



OPENING DEFINITION FOR DIRECTION OF DOOR AND WINDOW

1. DEFINITION FOR DOOR OPEN DIRECTION

LOOKING FROM OUTSIDE, THE DOOR WITH HINGE ON THE LEFT (RIGHT) SIDE CALLED LEFT (RIGHT) OPENING DOOR. THE OPENING DIRECTION INDICATED AS FIGURE. THE CODE INDICATED AS LISTED.

OPENING DIRECTION OF DOOR	CODE
LEFT INWARD OPENING	5.0(LI)
LEFT OUTWARD OPENING	6.1(LO)
RIGHT INWARD OPENING	6.0(RI)
RIGHT OUTWARD OPENING	5.1(RO)

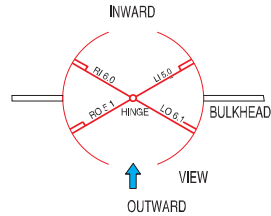

2. THE DEFINITION FOR WINDOW OPENING DIRECTION.

2.1 VIEW FROM HINGE SIDE, HINGE ON LEFT SIDE CALLED LEFT TYPE, HINGE SIDE CALLED RIGHT TYPE.



2.2 FOR INWARD OPENING ELECTROMAGNETIC SHIELDING WINDOW, LOOKING FROM THE OPENING SIDE, THE HINGE ON THE LEFT SIDE CALLED LEFT TYPE (A1), HINGE ON THE RIGHT SIDE CALLED RIGHT TYPE (A2)

ELECTROMAGNETIC SHIELDING WINDOW
RIGHT INWARD OPENING WINDOW (A2)

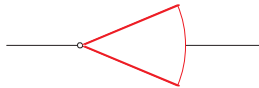

LEFT OUT OPENING WINDOW (B1)

ELECTROMAGNETIC SHIELDING WINDOW
LEFT INWARD OPENING WINDOW (A1)

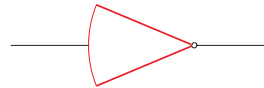

RIGHT OUT OPENING WINDOW (B2)

2.3 THE WINDOW WITH HINGE ON THE TOP CALLED TOP HINGED WINDOW.

3. OPENING DIRECTION DEFINITION FOR SLIDING WINDOW.

VIEW FROM INDOOR, OUTSIDE WINDOW LEAF OPENS TOWARD LEFT CALLED LEFT TYPE.
OUTSIDE WINDOW LEAF OPENS TOWARD RIGHT CALLED RIGHT TYPE.

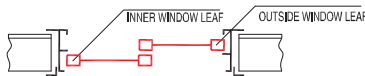

LEFT TYPE (L)

INDOOR

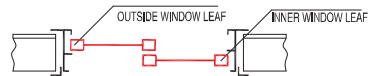

RIGHT TYPE (R)

INDOOR



GB/T 3477-2008

MARINE WEATHERTIGHT SINGLE-LEAF STEEL DOOR

USED FOR DOORWAY OF SUPERSTRUCTURE ABOVE FREEBOARD DECK OR DECK HOUSE TO MEET ISO 6042-1998

1. CLASS OF DOOR AND USED FOR STATION

CLASS	USED FOR STATION
A	FORWARD BULKHEAD ON THE FIRST DECK ABOVE FREEBOARD [FROM AFT. PERPENDICULAR TO (0.1L-0.7L)]
B	FORWARD BULKHEAD ON THE SECOND DECK ABOVE FREEBOARD [FROM AFT. PERPENDICULAR TO (0.1L-0.7L)] AND AFT. & SIDE BULKHEAD ON THE FIRST DECK
C	FORWARD BULKHEAD ON THE THIRD DECK ABOVE FREEBOARD [FROM AFT. PERPENDICULAR TO (0.2L-0.6L)] AND AFT. & SIDE BULKHEAD ON THE SECOND DECK
D	BULKHEAD ON THE FORTH DECK AND UP ABOVE FREEBOARD, AFT. & SIDE BULKHEAD ON THE THIRD DECK

2. TYPE AND SPECIFICATION OF DOOR

TYPE	NAME	APPLICABLE DIMENSION
AF	CLASS A RECTANGULAR CORNER DOOR	1200X600, 1400X600, 1400X700, 1400X750, 1400X800, 1400X900 1500X600, 1500X700, 1500X800, 1600X600, 1600X700, 1600X750 1600X800, 1600X900, 1650X650, 1650X700, 1700X600, 1700X700 1700X800
AY	CLASS A ROUND CORNER DOOR	
BF	CLASS B RECTANGULAR CORNER DOOR	
BY	CLASS B ROUND CORNER DOOR	
CF	CLASS C RECTANGULAR CORNER DOOR	
CY	CLASS C ROUND CORNER DOOR	1200X600, 1400X600, 1400X700, 1400X750, 1400X800, 1400X900 1500X600, 1500X700, 1500X800, 1600X600, 1600X700, 1600X750 1600X800, 1600X900, 1650X650, 1650X700, 1700X600, 1700X700 1700X800, 1800X600, 1800X750, 1800X900
DF	CLASS D RECTANGULAR CORNER DOOR	
DY	CLASS D ROUND CORNER DOOR	

NOTE: 1. HOOK, BUMPER, DOOR CLOSER, C2 LOCK AND ISPS DEVICE COULD BE EQUIPPED ACC. TO CUSTOMER'S REQUIREMENTS.
 2. CLASS C & D DOOR MAY BE EQUIPPED WITH ϕ 250 mm PORT LIGHT, THE CODE IS "G".

3. SECTION OF DOOR

THICKNESS OF DOOR t	SIZE OF SEAL RETAINER h1Xt1	HEIGHT OF DOOR FRAME h	MATERIAL OF DOOR FRAME
8	50X6	32	CUT FROM L100X63X10
6	32X4	34	
4			36

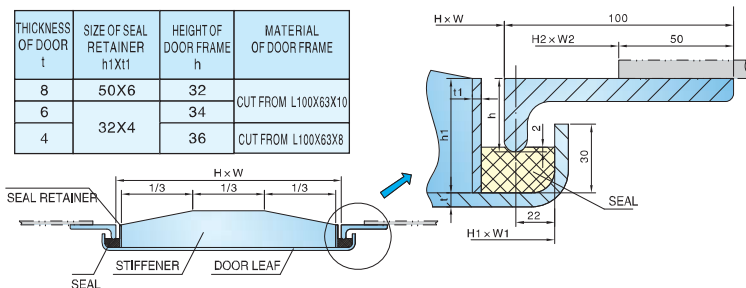



GB/T 3477-2008

MARINE WEATHERTIGHT SINGLE-LEAF STEEL DOOR

4. TYPE AF AY STEEL DOOR

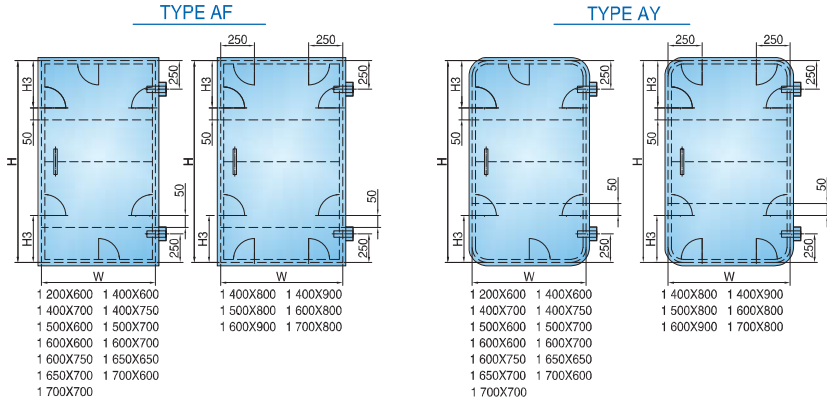

SIZE OF DOORWAY HxW	SIZE OF DOOR H1xW1	SIZE OF B. H. OPENING H2xW2		THICK OF DOOR LEAF		STIFFENER					QTY. AND INSTALL. OF DOGS		WEIGHT KG			
						SHIP LENGTH(m)										
						≤80	>80	80-120	120-150	150-210					210-300	
1200X600	1255X655	1300X700	R80	1300X700	R150	6	—	75X6	—	—	—	—	350	6	123.80	—
1400X600	1455X655	1500X700	R80	1500X700	R150	6	8	—	65X9	65X9	75X9	75X9	380	6	152.33	176.56
1400X700	1455X755	1500X800	R80	1500X800	R150	6	8	—	75X9	75X12	75X12	90X12	380	6	158.26	180.00
1400X750	1455X805	1500X850	R80	1500X850	R150	6	8	—	75X9	75X12	90X9	90X12	380	6	162.24	192.33
1400X800	1455X855	1500X900	R80	1500X900	R150	—	8	—	90X12	90X12	90X12	90X12	380	8	—	204.66
1400X900	1455X955	1500X1000	R80	1500X1000	R150	—	8	—	90X9	90X12	100X12	100X12	380	8	—	222.47
1500X600	1555X655	1600X700	R80	1600X700	R150	—	8	—	75X6	90X12	75X12	90X12	410	6	—	164.43
1500X700	1555X755	1600X800	R80	1600X800	R150	—	8	—	75X12	75X9	75X12	90X12	410	6	—	188.62
1500X800	1555X855	1600X900	R80	1600X900	R150	—	8	—	90X12	90X12	90X12	90X12	410	8	—	217.80
1600X600	1655X655	1700X700	R80	1700X700	R150	—	8	—	65X9	75X9	75X12	75X12	410	6	—	188.14
1600X700	1655X755	1700X800	R80	1700X800	R150	—	8	—	75X12	90X12	90X12	90X12	410	6	—	217.14
1600X750	1655X805	1700X850	R80	1700X850	R150	—	8	—	75X12	90X9	90X12	90X12	410	6	—	216.48
1600X800	1655X855	1700X900	R80	1700X900	R150	—	8	—	90X12	100X12	100X12	90X12	410	8	—	219.25
1600X900	1655X955	1700X1000	R80	1700X1000	R150	—	8	—	90X12	100X12	125X9	125X9	410	8	—	242.57
1650X650	1705X705	1750X750	R80	1750X750	R150	—	8	—	75X6	90X9	90X12	90X12	410	6	—	186.59
1650X700	1705X755	1750X800	R80	1750X800	R150	—	8	—	75X12	90X12	90X12	90X12	410	6	—	200.59
1700X600	1755X655	1800X700	R80	1800X700	R150	—	8	—	75X6	90X9	90X12	90X9	410	6	—	179.59
1700X700	1755X755	1800X800	R80	1800X800	R150	—	8	—	75X12	90X12	125X9	125X9	410	6	—	205.25
1700X800	1755X855	1800X900	R80	1800X900	R150	—	8	—	90X12	100X12	125X9	125X9	410	6	—	230.90

AF1600X600-8-65X9-5.1 GB/T 3477-2008.



GB/T 3477-2008
MARINE WEATHERTIGHT SINGLE-LEAF STEEL DOOR

5. TYPE BF BY CF CY STEEL DOOR

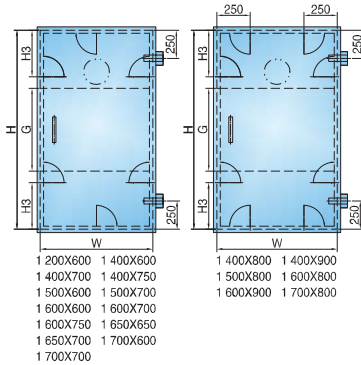
TYPE BF, CF

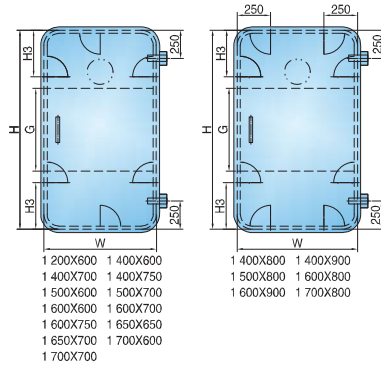

TYPE BY, CY

 1 200X600 1 400X600
 1 400X700 1 400X750
 1 500X600 1 500X700
 1 600X600 1 600X700
 1 600X750 1 650X650
 1 650X700 1 700X600
 1 700X700

 1 400X800 1 400X900
 1 500X800 1 600X800
 1 600X900 1 700X800

 1 200X600 1 400X600
 1 400X700 1 400X750
 1 500X600 1 500X700
 1 600X600 1 600X700
 1 600X750 1 650X650
 1 650X700 1 700X600
 1 700X700

 1 400X800 1 400X900
 1 500X800 1 600X800
 1 600X900 1 700X800

SIZE OF DOORWAY HxW	SIZE OF DOOR H1xW1	SIZE OF B. H. OPENING H2xW2		THICK. OF DOOR LEAF		STIFFENER						QTY. AND INSTALL. OF DOGS			WEIGHT KG							
				B	C	B			C													
				SHIP LENGTH(m)						G												
				≤80	>80	≤80	80-150	150-210	210-300		≤80							80-140	140-300			
1200X600	1255X655	1300X700	R80	1300X700	R150	6	-	4	-	50X5	-	-	-	50X5	-	-	400	6	350	85.93	122.23	-
1400X600	1455X655	1500X700	R80	1500X700	R150	6	8	4	6	50X5	65X6	65X9	65X9	50X5	65X6	65X6	460	6	350	97.25	141.15	170.78
1400X700	1455X755	1500X800	R80	1500X800	R150	6	8	4	6	50X5	65X9	75X9	75X9	50X5	65X6	65X6	460	6	350	116.26	144.15	172.30
1400X750	1455X805	1500X850	R80	1500X850	R150	6	8	4	6	50X5	69X9	75X9	75X9	50X5	65X6	65X6	460	6	350	122.54	152.01	184.10
1400X800	1455X855	1500X900	R80	1500X900	R150	-	8	-	6	-	75X9	75X9	75X12	-	65X6	65X6	460	8	350	-	182.48	195.30
1400X900	1455X955	1500X1000	R80	1500X1000	R150	-	8	-	6	-	75X9	75X12	75X12	-	65X6	65X9	460	8	350	-	198.12	210.81
1500X600	1555X655	1600X700	R80	1600X700	R150	-	8	-	6	-	65X6	65X9	75X9	-	65X6	65X6	540	6	350	-	133.38	160.50
1500X700	1555X755	1600X800	R80	1600X800	R150	-	8	-	6	-	65X9	75X9	75X9	-	65X6	65X6	540	6	350	-	154.83	184.10
1500X800	1555X855	1600X900	R80	1600X900	R150	-	8	-	6	-	75X9	75X12	75X12	-	65X6	65X6	540	8	350	-	173.98	207.70
1600X600	1655X655	1700X700	R80	1700X700	R150	-	8	-	6	-	65X6	65X9	65X9	-	65X6	65X6	540	6	410	-	147.83	175.86
1600X700	1655X755	1700X800	R80	1700X800	R150	-	8	-	6	-	65X9	75X9	75X12	-	65X6	65X6	540	6	410	-	141.95	190.03
1600X750	1655X805	1700X850	R80	1700X850	R150	-	8	-	6	-	65X6	75X9	75X12	-	65X6	65X6	540	6	410	-	151.11	201.48
1600X800	1655X855	1700X900	R80	1700X900	R150	-	8	-	6	-	75X9	75X12	90X12	-	65X6	65X6	540	8	410	-	182.58	215.22
1600X900	1655X955	1700X1000	R80	1700X1000	R150	-	8	-	6	-	75X9	75X12	90X12	-	65X6	65X9	540	8	410	-	174.93	233.32
1650X650	1705X705	1750X750	R80	1750X750	R150	-	8	-	6	-	65X9	65X9	75X9	-	65X6	65X6	540	6	410	-	184.37	195.40
1650X700	1705X755	1750X800	R80	1750X800	R150	-	8	-	6	-	75X9	75X9	75X12	-	65X6	65X6	540	6	410	-	157.54	210.06
1700X600	1755X655	1800X700	R80	1800X700	R150	-	8	-	6	-	65X9	75X9	75X12	-	65X6	65X6	540	6	410	-	140.89	188.08
1700X700	1755X755	1800X800	R80	1800X800	R150	-	8	-	6	-	75X9	75X12	90X12	-	65X6	65X9	540	6	410	-	181.21	214.35
1700X800	1755X855	1800X900	R80	1800X900	R150	-	8	-	6	-	75X9	75X12	90X12	-	65X6	65X9	540	8	410	-	181.38	241.82

BY1600X600-8-65X9-5.1 GB/T 3477-2008.



GB/T 3477-2008

MARINE WEATHERTIGHT SINGLE-LEAF STEEL DOOR

6. TYPE DF DY STEEL DOOR

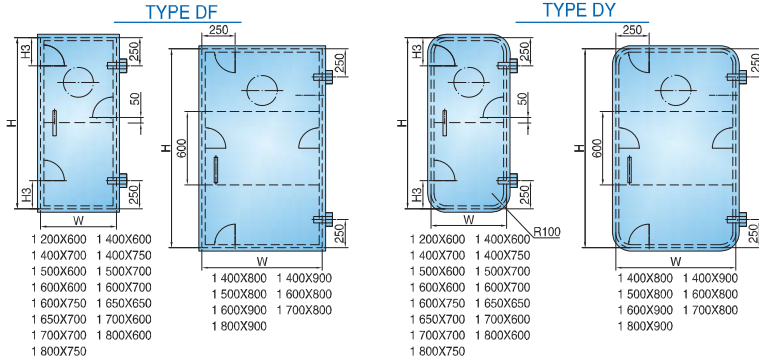

SIZE OF DOORWAY HxW	SIZE OF DOOR H1xW1	SIZE OF B. H. OPENING H2xW2			THK. OF DOOR LEAF	STIFFENER	QTY. AND INSTALL. OF DOGS			WEIGHT KG	
		DF	DY				QTY.	H3	4	6	
1200X600	1255X655	1300X700 R80	1300X700 R150	4	50X5	3	180	75.01	—	—	
1400X600	1455X655	1500X700 R80	1500X700 R150	4	50X5	3	180	97.25	—	—	
1400X700	1455X755	1500X800 R80	1500X800 R150	4	50X5	3	180	99.20	—	—	
1400X750	1455X805	1500X850 R80	1500X850 R150	4	50X5	3	180	102.54	—	—	
1400X800	1455X855	1500X900 R80	1500X900 R150	4	50X5	4	—	107.80	—	—	
1400X900	1455X955	1500X1000 R80	1500X1000 R150	4	50X5	4	—	134.81	—	—	
1500X600	1555X655	1600X700 R80	1600X700 R150	6	65X6	3	180	—	131.63	—	
1500X700	1555X755	1600X800 R80	1600X800 R150	6	65X6	3	180	—	133.20	—	
1500X800	1555X855	1600X900 R80	1600X900 R150	6	65X6	3	180	—	135.45	—	
1600X600	1655X655	1700X700 R80	1700X700 R150	6	65X6	3	180	—	139.37	—	
1600X700	1655X755	1700X800 R80	1700X800 R150	6	65X6	3	180	—	147.33	—	
1600X750	1655X805	1700X850 R80	1700X850 R150	6	65X6	3	180	—	156.83	—	
1600X800	1655X855	1700X900 R80	1700X900 R150	6	65X6	4	—	—	162.54	—	
1600X900	1655X955	1700X1000 R80	1700X1000 R150	6	65X6	4	—	—	178.57	—	
1650X650	1705X705	1750X750 R80	1750X750 R150	6	65X6	3	180	—	137.36	—	
1650X700	1705X755	1750X800 R80	1750X800 R150	6	65X6	3	180	—	148.80	—	
1700X600	1755X655	1800X700 R80	1800X700 R150	6	65X6	3	180	—	132.78	—	
1700X700	1755X755	1800X800 R80	1800X800 R150	6	65X6	3	180	—	151.10	—	
1700X800	1755X855	1800X900 R80	1800X900 R150	6	65X6	4	—	—	169.41	—	
1800X600	1855X655	1900X700 R80	1900X700 R150	6	65X6	3	180	—	136.91	—	
1800X750	1855X805	1900X850 R80	1900X850 R150	6	65X6	3	180	—	156.83	—	
1800X900	1855X955	1900X1000 R80	1900X1000 R150	6	65X6	4	—	—	178.57	—	

DF1400X750-4-50X5-5.1 GB/T 3477-2008.



STEEL QUICK ACTION WEATHERTIGHT DOOR/WATERTIGHT DOOR **262WHL003M-00**

THESE TWO TYPE DOORS COULD BE USED AS BOTH WEATHERTIGHT AND WATERTIGHT DOOR WHILE USED AS WATERTIGHT DOOR, THE PRESSURE NO MORE THAN 0.07MPa

262WHL003A-00

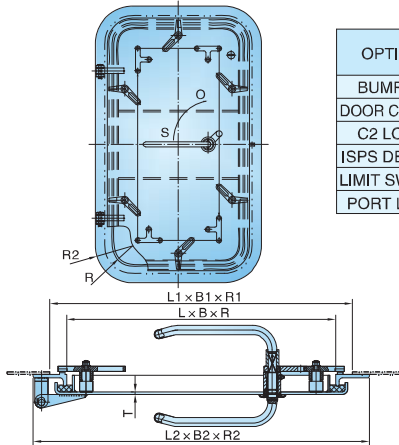

262WHL003M-00

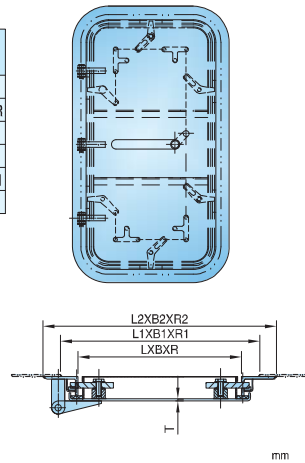

OPTION
BUMPER
DOOR CLOSER
C2 LOCK
ISPS DEVICE
LIMIT SWITCH
PORT LIGHT

SIZE OF DOORWAY LXBXR	SIZE OF B.H.OPENING L1XB1XR1	SIZE OF OUTLINE L2XB2XR2	THICKNESS T	WEIGHT kg	
				262WHL003A-00	262WHL003M-00
1400X600XR100	1500X700XR150	1600X800XR200	6	120	129
			8	138	147
1400X900XR100	1500X1000XR150	1600X1100XR200	6	145	160
			8	175	185
1600X600XR100	1700X700XR150	1800X800XR200	6	126	137
			8	144	155
1600X750XR100	1700X850XR150	1800X950XR200	6	147	161
			8	172	186
1600X900XR100	1700X1000XR150	1800X1100XR200	6	163	178
			8	191	206

262WHL003A-00

1600X600-8-6.1 262WHL003A-00



262WHL002-00

QUICK OPEN&CLOSE WEATHERTIGHT STEEL DOOR (FLUSH TYPE)

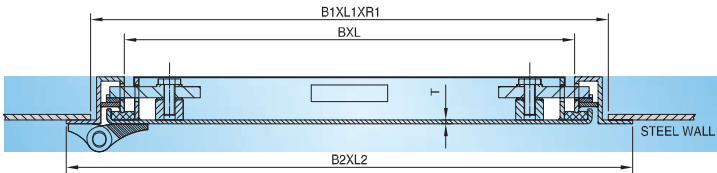
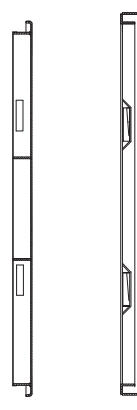
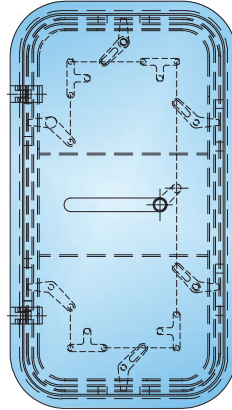

mm

SIZE OF DOORWAY BXL	SIZE OF B.H. OPENING B1XL1XR1	FRAME SIZE B2XL2	WEIGHT KG	
			THICK. OF DOOR LEAF	
			6	8
600X1650	720X1770X160	786X1836	166	191
650X1650	770X1770X160	836X1836	177	205
700X1650	820X1770X160	886X1836	188	219

OPTION
BUMPER
DOOR CLOSER
C2 LOCK
ISPS DEVICE
LIMIT SWITCH
PORT LIGHT

650X1650-6-6.1 262WHL-002-00



262WHL097-00 QUICK OPEN&CLOSE WEATHERTIGHT STEEL DOOR(HAND WHEEL TYPE)

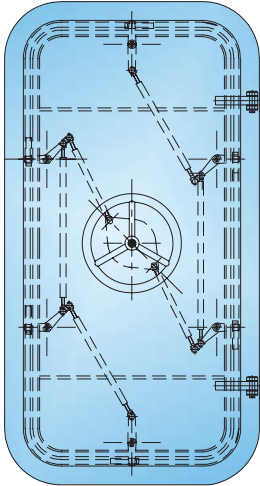

OPTION
BUMPER
DOOR CLOSER
C2 LOCK
ISPS DEVICE
LIMIT SWITCH
PORT LIGHT

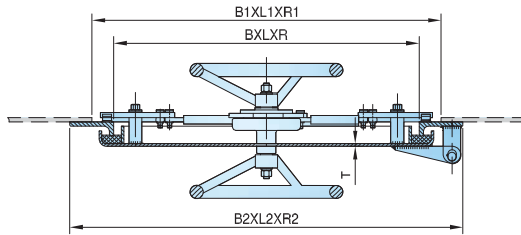

mm

SIZE OF DOORWAY BXLXR	SIZE OF B.H. OPENING B1XL1XR1	SIZE OF OUTLINE B2XL2XR2	THICKNESS T		WEIGHT kg	
600X1500X100	700x1600x150	800X1700X200	6	8	145	166
600X1600X100	700x1700x150	800X1800X200	6	8	154	176
700X1500X100	800x1600x150	900X1700X200	6	8	167	191
700X1600X100	800x1700x150	900X1800X200	6	8	174	199
700X1700X100	800x1800x150	900X1900X200	6	8	183	210
800X1500X100	900x1600x150	1000X1700X200	8		208	
800X1600X100	900x1700x150	1000X1800X200	8		223	
800X1700X100	900x1800x150	1000X1900X200	8		249	

600X1600-8-5.1 262WHL-097-00



262WHL003MS-00

STEEL DOUBLE-LEAF QUICK ACTION WEATHERTIGHT DOOR

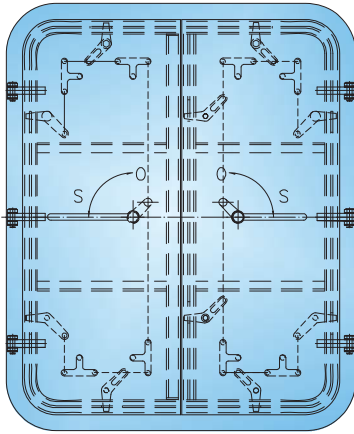

OPTION
BUMPER
DOOR CLOSER
C2 LOCK
ISPS DEVICE
LIMIT SWITCH
PORT LIGHT

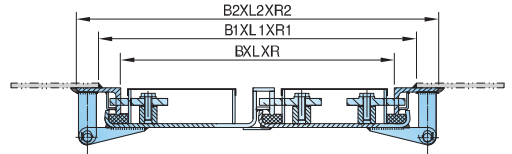

SIZE OF DOORWAY BXL	SIZE OF B,H OPENING B1XL1XR1	SIZE OF OUT LINE B2XL2	THICKNESS T	WEIGHT KG
1000X1600XR100	1100X1700XR150	1200X1800XR200	6	203
			8	241
1200X1600XR100	1300X1700XR150	1400X1800XR200	6	230
			8	265
1000X1700XR100	1100X1800XR150	1200X1900XR200	6	216
			8	247
1200X1700XR100	1300X1800XR150	1400X1900XR200	6	241
			8	278
1200X1800XR100	1300X1900XR150	1400X2000XR200	6	250
			8	289

1000X1600-8-5.1&6.1 262WHL003MS-00



262WHL095-00

STEEL PRESSURE RESISTANT WATERTIGHT DOOR

THE APPLICABLE WATER PRESSURE FOR THE DOOR IS NO MORE THAN 0.15MPa.

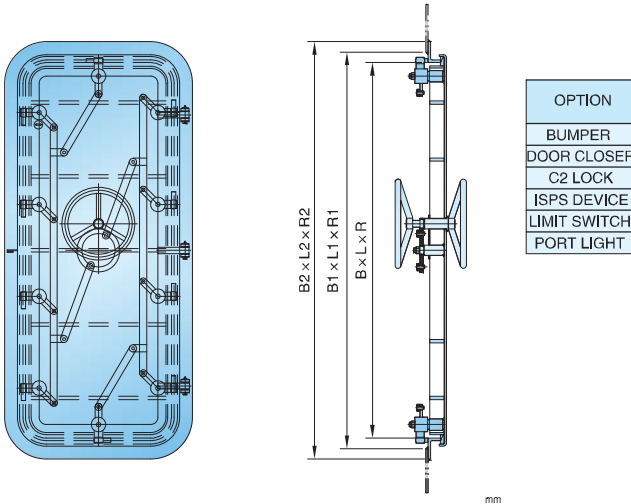

SIZE OF DOORWAY BXLXR	SIZE OF B.H.OPENING B1XL1XR1	SIZE OF OUT LINE B2XL2XR2	THICKNESS T	WEIGHT KG
600X1500X100	700X1600X150	800X1700X200	8	206
600X1600X100	700X1700X150	800X1800X200		212
700X1500X100	800X1600X150	900X1700X200		227
700X1600X100	800X1700X150	900X1800X200		239
700X1700X100	800X1800X150	900X1900X200		250
800X1500X100	900X1600X150	1000X1700X200		248
800X1600X100	900X1700X150	1000X1800X200		263
800X1700X100	900X1800X150	1000X1900X200		289

600X1500-8-5.1 262WHL095-00



262WHL095C-00

STEEL HIGH PRESSURE RESISTANT WATERTIGHT DOOR

THE APPLICABLE WATER PRESSURE FOR THE DOOR IS NO MORE THAN 0.5MPa.

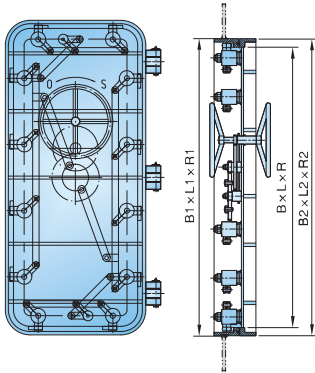

SIZE OF DOORWAY BXLXR	SIZE OF B.H.OPENING B1XL1XR1	FRAME SIZE B2XL2XR2	THICKNESS T
600X1600X100	705X1705X152.5	700X1700X150	SUBJECT TO ACTUAL PRESSURE
700X1500X100	805X1605X152.5	800X1600X150	
700X1600X100	805X1705X152.5	800X1700X150	
700X1700X100	805X1805X152.5	800X1800X150	
800X1500X100	905X1605X152.5	900X1600X150	
800X1600X100	905X1705X152.5	900X1700X150	
800X1700X100	905X1805X152.5	900X1800X150	

600X1500-8-5.1 262WHL095C-00

262WHL095F-00

A60 STEEL PRESSURE RESISTANT WATERTIGHT DOOR

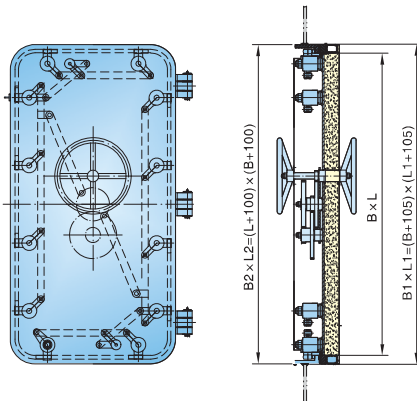

THE APPLICABLE WATER PRESSURE FOR THE DOOR IS NO MORE THAN 0,5 MPa, THE MAX. SIZE IS 1200X2300mm (width X height).

600X1500-8-5.1 262WHL095F-00

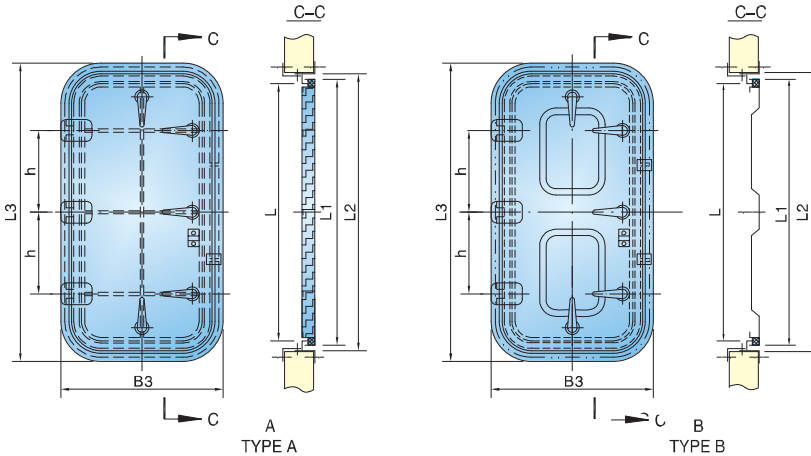
CB/T 454-1997
MARINE WEATHERTIGHT SINGLE-LEAF ALUMINIUM DOOR

TYPE	NAME	SIZE OF DOORWAY BXL			OPTION
A	FRAME TYPE WEATHERTIGHT SINGLE-LEAF ALUMINIUM DOOR	500X1000 600X1200	500X1200 600X1400	500X1400 650X1600	HOOK, BUMPER, PORTLIGHT
B	MOULD TYPE WEATHERTIGHT SINGLE-LEAF ALUMINIUM DOOR	500X1000	500X1200	600X1200	

SIZE OF DOORWAY BXLXR	SIZE OF DOOR B1XL1XR1	SIZE OF B.H. OPENING B2XL2XR2	SIZE OF OUTLINE B3XL3XR3	h	OUT. OF CLIPS	WEIGHT KG	
500X1000X100	540X1040X120	580X1080X140	654X1154X177	300	4	23	21
500X1200X100	540X1240X120	580X1280X140	654X1354X177	400	5	27	25
500X1400X100	540X1440X120	580X1480X140	654X1554X177	500	5	30	27
600X1200X100	640X1240X120	680X1280X140	754X1354X177	400	5	33	30
600X1400X100	640X1440X120	680X1480X140	754X1554X177	500	5	36	33
650X1600X100	690X1640X120	730X1680X140	804X1754X177	600	5	39.5	36

A600X1400-6.1 CB/T 454-1997



262WHL093D-00

QUICK OPEN & CLOSE WEATHERTIGHT ALUMINIUM DOOR

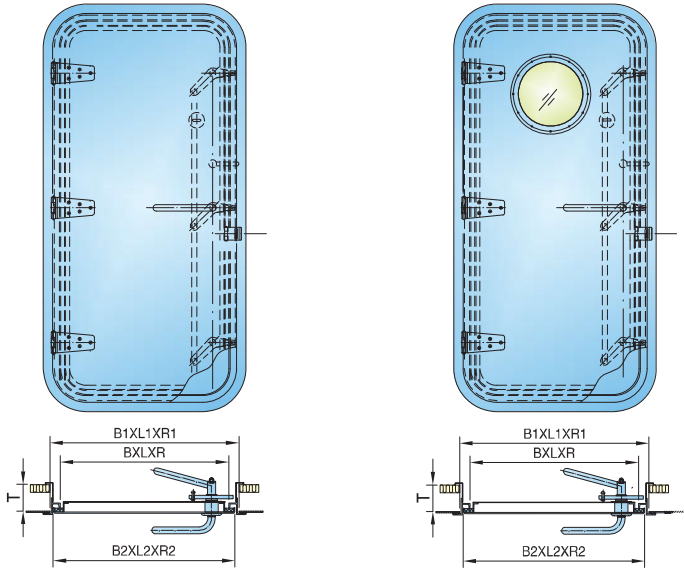

TYPE A QUICK OPEN & CLOSE WEATHERTIGHT ALUMINIUM DOOR TYPE B QUICK OPEN & CLOSE WEATHERTIGHT ALUMINIUM DOOR

mm

TYPE	SIZE OF DOORWAY BXLXR	SIZE OF B.H.OPENING B1XL1XR1	SIZE OF DOOR B2XL2XR2	THICKNESS	WEIGHT KG	OPTION
A	600X1200X100	680X1280X140	648X1248X124	4	32	HOOK BUMPER
	650X1400X100	730X1480X140	698X1448X124		35	
	650X1600X100	730X1680X140	698X1648X124		38	
	700X1600X100	780X1680X140	748X1648X124		39	
B	600X1200X100	680X1280X140	648X1248X124		34	
	650X1400X100	730X1480X140	698X1448X124		37	
	650X1600X100	730X1680X140	698X1648X124		40	
	700X1600X100	780X1680X140	748X1648X124		41	

A650X1600-6.1 262WHL093D-00

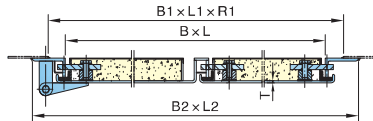
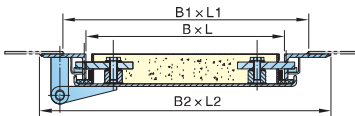
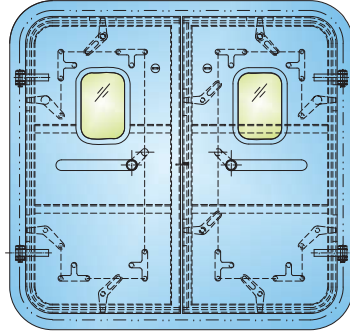
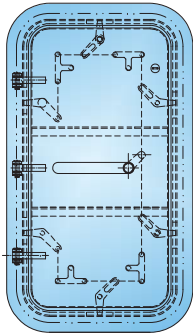
A60 QUICK OPEN & CLOSE WEATHERTIGHT STEEL DOOR(SINGLE,DOUBLE)
262WHL003FM-00
262WHL601-00

A60 QUICK OPEN & CLOSE WEATHERTIGHT STEEL DOOR (SINGLE)

A60 QUICK OPEN & CLOSE WEATHERTIGHT STEEL DOOR (DOUBLE)

262WHL003FM-00
262WHL601-00

TYPE	SIZE OF DOORWAY BXL	SIZE OF B.H.OPENING B1XL1XR1	FRAME SIZE B2XL2	WEIGHT KG	OPTION
SINGLE LEAF 262WHL003FM-00	600X1650	700X1750X150	800X1850	200	BUMPER DOOR CLOSER C2 LOCK ISPS DEVICE LIMIT SWITCH PORT LIGHT
	700X1650	800X1750X150	900X1850	210	
	800X1800	900X1900X150	1000X2000	248	
	1200X2300	1300X2400X150	1400X2500	404	
DOUBLE LEAF 262WHL601-00	900X1650	1000X1750X150	1100X1850	300	
	1000X1650	1100X1750X150	1200X1850	340	
	1200X1650	1300X1750X150	1400X1850	357	
	2400X2500	2500X2600X150	2600X2700	825	

NOTE: THE WEIGHT IS CALCULATED BASED ON THAT T=8mm.

1200X1650-8-5.1 & 6.1 262WHL601-00



262WHL041-00

A60 QUICK OPEN & CLOSE WEATHERTIGHT STEEL DOOR

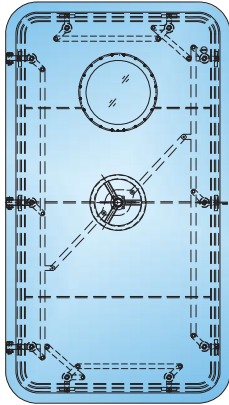

OPTION
BUMPER
DOOR CLOSER
C2 LOCK
ISPS DEVICE
LIMIT SWITCH
PORT LIGHT

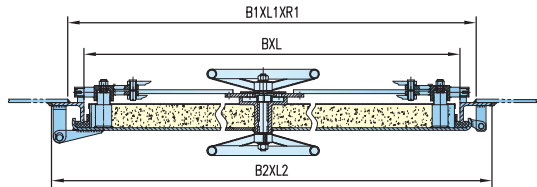

SIZE OF DOORWAY BXL	SIZE OF B.H.OPENING B1XL1XR1	FRAME SIZE B2XL2	WEIGHT KG
600X1650	700X1750X150	800X1850	220
700X1650	800X1750X150	900X1850	230
800X1800	900X1900X150	1000X2000	268
1200X2300	1300X2400X150	1400X2500	424

NOTE: THE WEIGHT IS CALCULATED BASED ON THAT T=8mm.

600X1650-8-6.1 262WHL041-00

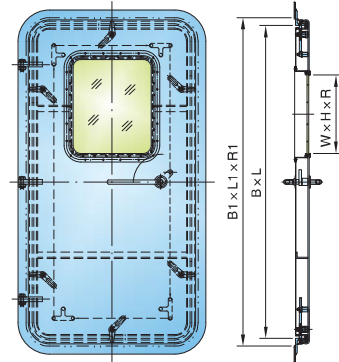
262WHL040-00
A0 QUICK OPEN & CLOSE WEATHERTIGHT STEEL DOOR(WITH WINDOW)

SIZE OF DOORWAY BXL	SIZE OF B.H. OPENING B1XL1XR1	FRAME SIZE B2XL2	MAX. CLEAR SIZE OF WINDOW WXH	mm	
				WEIGHT KG	t=8mm
700X1600	800X1700X150	900X1800	200X400	184	
700X1700	800X1800X150	900X1900	200X450	188	
800X1600	900X1700X150	1000X1800	300X400	194	
800X1700	900X1800X150	1000X1900	300X450	198	
900X1700	1000X1800X150	1100X1900	400X450	208	
900X1800	1000X1900X150	1100X2000	400X500	219	
1000X2000	1100X2100X150	1200X2200	500X600	243	

NOTE: BUMPER, DOOR CLOSER, C2 LOCK, ISPS DEVICE AND PORTLIGHT MAY BE EQUIPPED ACC. TO CUSTOMER'S REQUIREMENTS.

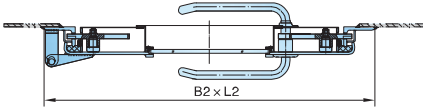
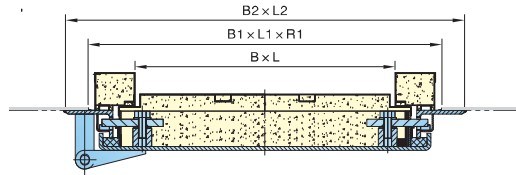
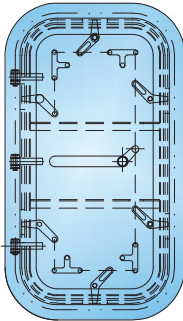
262WHL006FM-00
H120 FIREPROOF QUICK OPEN & CLOSE WEATHERTIGHT DOOR

SIZE OF DOORWAY BXL	SIZE OF B.H. OPENING B1XL1XR1	SIZE OF OUTLINE B2XL2	THICKNESS T	mm	
				WEIGHT KG	
700X1500	900X1700X200	996X1796	8	235	
700X1600	900X1800X200	996X1896	8	240	
800X1500	1000X1700X200	1096X1796	8	245	
800X1600	1000X1800X200	1096X1896	8	255	
900X1900	1100X2100X200	1196X2196	8	285	

NOTE: BUMPER, DOOR CLOSER, C2 LOCK AND ISPS DEVICE MAY BE EQUIPPED ACC. TO CUSTOMER'S REQUIREMENTS.

700X1500-8-6.1 262WHL006FM-00



A60 STEEL SINGLE-LEAF WATERTIGHT DOOR (WITH SMALL DOOR)

THE DOOR IS MAINLY USED AT SUCH PASSAGE WAYS AND PLACES, WHERE BIG TYPE EQUIPMENT SHOULD BE LIFTED AND MOVED, AND NORMALLY THE SMALL DOOR IS USED AS ACCESS DOOR AND SOMETIME THE BIG DOOR COULD BE OPENED FOR LIFTING BIG TYPE EQUIPMENT.

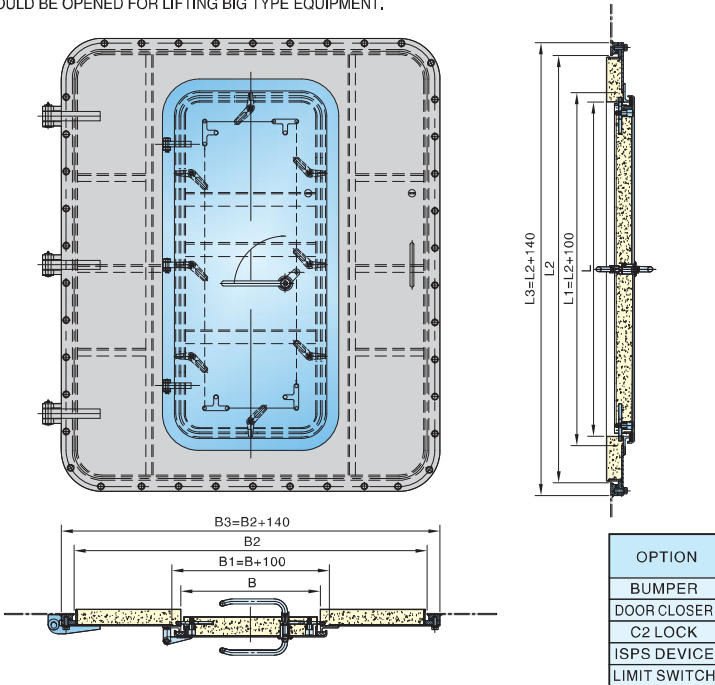

LXB IS DOORWAY SIZE OF SMALL DOOR ,2000X1100 mm MAX.
 L1XB1 IS CUT SIZE FOR SMALL DOOR
 L2XB2 IS DOORWAY SIZE OF BIG DOOR ,2300X2100mm MAX.
 L3XB3 IS OUTLINE SIZE OF BIG DOOR

2300X1900-10-6.1/1800X750-8-6.1 262WHL603-00

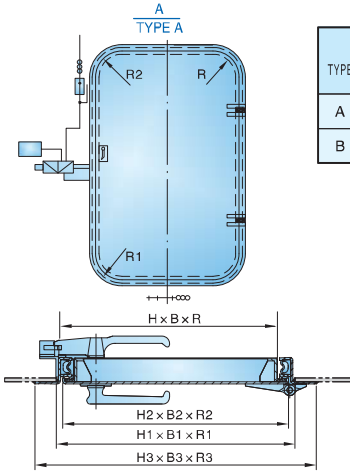
CB/T 3722-2011
GASTIGHT DOOR

TYPE	DESCRIPTION	OPENING DIRECTION	MATERIAL OF DOOR	GASTIGHT PERFORMANCE (PRESSURE DIFFERENCE)
A	HINGED GASTIGHT DOOR WITH INFLATABLE GASKET SEALING	L	N	500pa
B	SLIDING GASTIGHT DOOR WITH MECHANICAL TIGHTENING SEALING	R	L	0

SIZE OF DOORWAY HXBXR	SIZE OF B.H. OPENING H1XB1XR1	SIZE OF DOOR LEAF H2XB2XR2	SIZE OF DOOR FRAME H3XB3XR3	WEIGHT kg	
				N	L
1600X600 R100	1685X685 R142	1650X650 R125	1800X800 R200	64	44
1650X650 R100	1735X735 R142	1700X700 R125	1850X850 R200	70	46
1700X700 R100	1785X785 R142	1750X750 R125	1900X900 R200	78	52
1750X700 R100	1835X785 R142	1800X750 R125	1950X900 R200	80	54
1700X750 R100	1785X835 R142	1750X800 R125	1900X950 R200	83	56
1750X750 R100	1835X835 R142	1800X800 R125	1950X950 R200	85	59
1800X750 R100	1885X835 R142	1850X800 R125	2000X950 R200	87	62
1800X800 R100	1885X885 R142	1850X850 R125	2000X1000 R200	92	66

**B
TYPE B**

SIZE OF DOORWAY HXB	SIZE OF B.H. OPENING H1XB1	SIZE OF DOOR LEAF H2XB2	SLIDE WAY B3	WEIGHT kg	
				N	L
1700X750	1785X835	1850X830	1950	178	125
1700X900	1785X985	1850X980	2100	191	133
1800X750	1885X835	1950X830	1950	182	128
1800X900	1885X985	1950X980	2100	195	136
1800X1000	1885X1085	1950X1080	2200	204	142

D=200mm.

THE WEIGHT IS CALCULATED AT D=200mm.

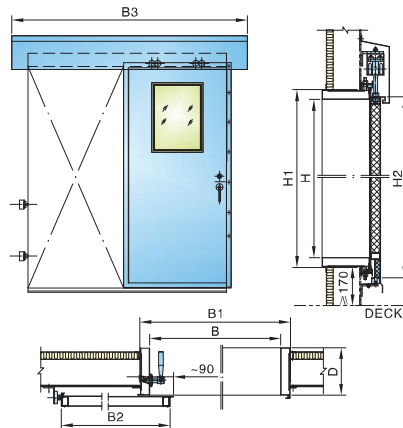

1700X750mm A

AR1700X750L CB/T 3722-2011

1700X750mm 100mm B

BL1700X750X100N CB/T 3722-2011



(TYPE A FOR CABIN)A60 WEATHERTIGHT AND GASTIGHT DOOR (SINGLE-LEAF,DOUBLE-LEAF)

262WHL005MS-00

SINGLE-LEAF
262WHL005M-00

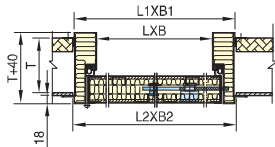
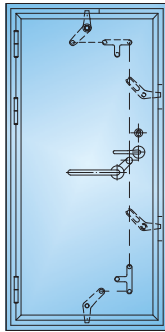

DOUBLE-LEAF
262WHL005MS-00

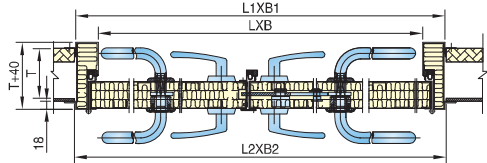
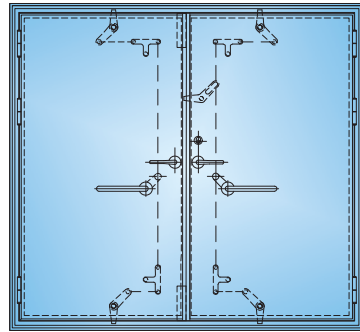

TYPE	SIZE OF DOORWAY LXB	FRAME SIZE L1XB1	SIZE OF B.H. OPENING L2XB2	WEIGHT KG	OPTION
SINGLE-LEAF 262WHL005M-00	1600X600	1700X700	1705X705	118	DOOR CLOSER
	1650X650	1750X750	1755X755	128	
	1700X700	1800X800	1805X805	142	
	1750X800	1850X900	1855X905	149	
	1900X900	2000X1000	2005X1005	162	
DOUBLE-LEAF 262WHL005MS-00	1600X1000	1700X1100	1705X1105	172	DOOR STOPPER
	1650X1100	1750X1200	1755X1205	184	
	1700X1300	1800X1400	1805X1405	230	
	1750X1600	1850X1700	1855X1705	280	
	2000X1850	2100X1950	2105X1955	324	

1600X600 A60

A60 A601600X600-6.1 262WHL005M-00

1600X1000 A60

A60 A601600X1000-5.1 & 6.1 262WHL005MS-00



(TYPE B FOR CABIN)A60 WEATHERTIGHT AND GASTIGHT DOOR (SINGLE-LEAF,DOUBLE-LEAF)

262WHL651-00

SINGLE-LEAF
262WHL653-00

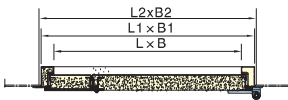
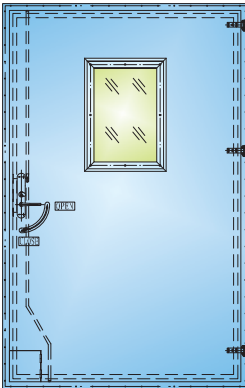

DOUBLE-LEAF
262WHL651-00

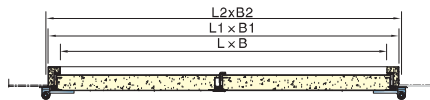
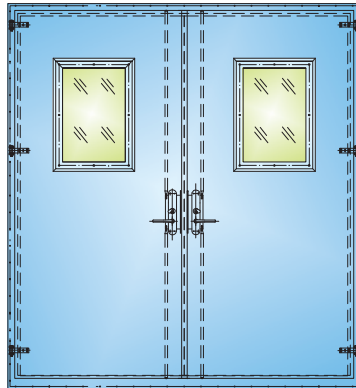

TYPE	SIZE OF DOORWAY LXB	FRAME SIZE L1XB1	SIZE OF B.H.OPENING L2XB2	WEIGHT KG	OPTION
SINGLE LEAF 262WHL653-00	1600X600	1696X696	1700X700	116	闭门器 定门器 DOOR CLOSER DOOR STOPPER
	1650X650	1746X746	1750X750	123	
	1700X700	1796X796	1800X800	133	
	1750X800	1846X896	1850X900	145	
	2400X1400	2496X1496	2500X1500	276	
DOUBLE LEAF 262WHL651-00	1600X1000	1696X1096	1700X1100	174	DOOR CLOSER DOOR STOPPER
	1650X1100	1746X1196	1750X1200	187	
	1700X1300	1796X1396	1800X1400	213	
	1750X1600	1846X1696	1850X1700	249	
	2500X2300	2596X2396	2600X2400	427	

1600X600 A60

A60 A601600X600-5.1 262WHL653-00

1600X1000 A60

A60 A601600X1000-5.1 & 6.1 262WHL651-00



SLIDING DOOR FOR WHEELHOUSE

262WHL055-00
CBM2055-82

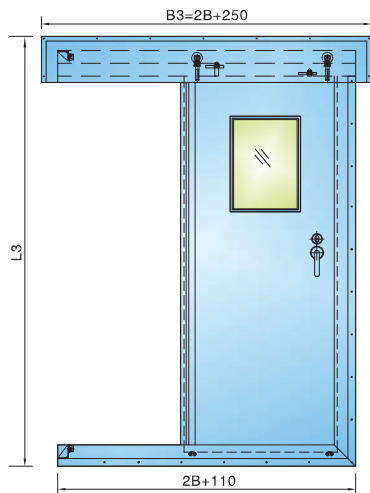

THIS PRODUCT IS MADE IN ACCORDANCE WITH ISO STANDARD, WITH MERITS OF LOW NOISE, FINE APPEARANCE AND LIGHTY, WHICH CAN BE USED FOR VARIOUS KINDS OF SHIPS.

A	STAINLESS STEEL
B	ALUMINIUM
C	ALUMINIUM DOOR BOARD, OTHER STEEL

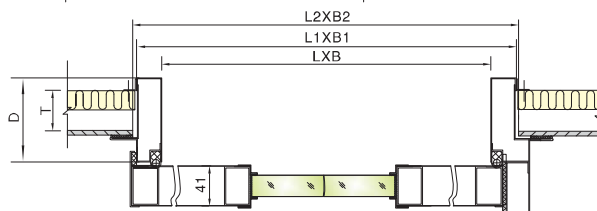

TYPE	SIZE OF DOORWAY LXB	FRAME SIZE L1XB1	SIZE OF B.H. OPENING L2XB2	SIZE OF OUTLINE L3XB3	D	OPENING	WEIGHT(KG)			
							A	B	C	
A	1700X750	1780X830	1785X835	2100X1750	T+70	左 L	56	42	40	
	1700X900	1780X980	1785X985	2100X2050			62	48	46	
B	1800X900	1880X980	1885X985	2200X2050			右 R	66	52	50
	1800X1000	1880X1080	1885X1085	2200X2250				72	58	56

1800X900mm D200

A1800X900-200L 262WHL055-00



262WHL035C-00

STAINLESS STEEL/ALUMINIUM SINGLE-LEAF SLIDING DOOR FOR CABIN

USED FOR THE CABIN INSIDE SHIP SUPERSTRUCTURE. THE SURFACE OF DOOR IS OXIDED OR PVC COVERED.

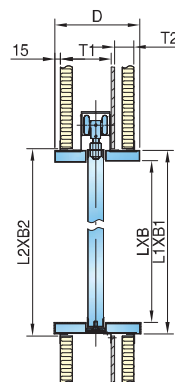
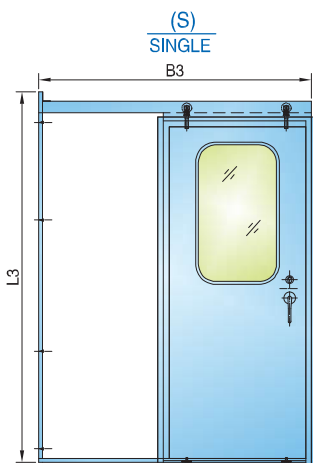

- A: BASE MODE
- B: WITH FIXED LIGHT
- C: WITH VENTILATOR ESCAPE HOLE
- D: WITH FIXED LIGHT & VENT ESCAPE EXIT

N	STAINLESS STEEL
L	ALUMINIUM

TYPE	SIZE OF DOORWAY LXB	FRAME SIZE L1XB1	SIZE OF H. OPENING L2XB2	SIZE OF DOOR L3XB3	D ≥76	OPENING	WEIGHT KG								
							ALUMINIUM				STAINLESS STEEL				
							A	B	C	D	A	B	C	D	
SINGLE	A	1600X600	1660X660	1665X665	1760X1200	T1+T2+35	L	29	31	31	33	75	77	77	79
		1650X650	1710X710	1715X715	1810X1300			31	33	33	35	81	83	83	85
	B	1750X700	1810X760	1815X765	1910X1400			33	35	35	37	86	88	88	90
		1750X800	1810X860	1815X865	1910X1600			36	38	38	40	94	96	96	98
	C	1600X1200	1660X1260	1665X1265	1760X2400			57	61	61	65	148	152	152	156
		1650X1300	1710X1360	1715X1365	1810X2600			61	65	65	69	159	163	163	167
	D	1750X1400	1810X1460	1815X1465	1910X2800			65	69	69	73	169	173	173	177
		1750X1600	1810X1660	1815X1665	1910X3200			71	75	75	79	185	185	189	193

1600X600 D200

SL-B1600X600-200L 262WHL035-00

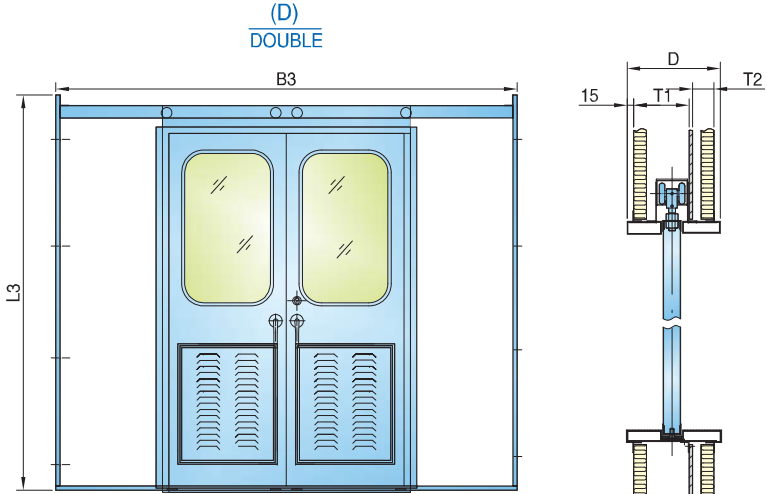

262WHL035A-00
STAINLESS STEEL/ALUMINIUM DOUBLE-LEAF SLIDING DOOR FOR CABIN

A: BASE MODE

B: WITH FIXED LIGHT

C: WITH VENTILATOR ESCAPE HOLE

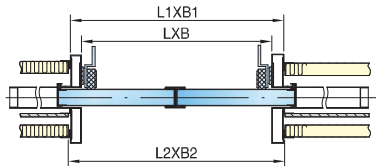
D: WITH FIXED LIGHT & VENT ESCAPE EXIT



TYPE	SIZE OF DOORWAY LXB	FRAME SIZE L1XB1	SIZE OF B.H. OPENING L2XB2	SIZE OF OUTLINE L3XB3	D ≥76	WEIGHT KG								
						ALUMINIUM				STAINLESS STEEL				
						A	B	C	D	A	B	C	D	
DOUBLE	A	1600X1200	1660X1260	1665X1265	1760X2360	T1+T2+35	63	71	71	79	163	171	171	179
	B	1650X1300	1710X1360	1715X1365	1810X2560		67	75	75	83	175	183	183	191
	C	1750X1400	1810X1460	1815X1465	1910X2760		72	80	80	88	186	194	194	202
	D	1750X1600	1810X1660	1815X1665	1910X3160		78	86	86	94	204	212	212	220

1600X1200 D250

DN-D1600X1200-250 262WHL035-00

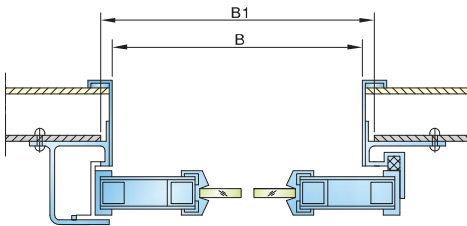
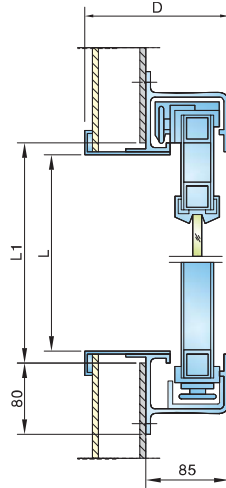
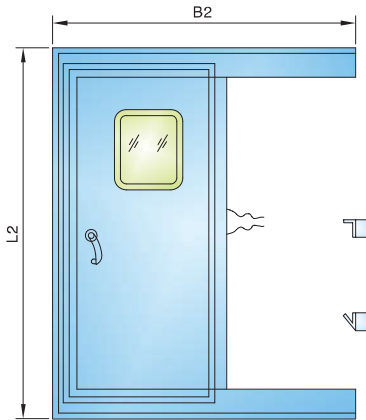
262WHL056-00
ALUMINIUM ALLOY SPRAYTIGHT SLIDING DOOR FOR WHEELHOUSE

SIZE OF DOORWAY LXB	SIZE OF B.H. OPENING L1XB1	SIZE OF OUTLINE L2XB2	D	OPENING	WEIGHT KG
1700X750	1715X765	1875X1530	90-200	左 L	42.1
1700X900	1715X915	1875X1830			48.3
1800X900	1815X915	1975X1830		右 R	52.4
1800X1000	1815X1015	1975X2030			58.7

1700X900 D90

L-1700X900-90R 262WHL056-00



262WHL044A/B-00

ALUMINIUM/STAINLESS STEEL WEATHERTIGHT DOOR FOR WEATHER WALL (SINGLE/DOUBLE)

USED FOR ENTRANCE DOOR OF SHIP SUPER STRUCTURE,
WHICH HAS GOOD WEATHERTIGHTNESS AND GASTIGHTNESS.

N	STAINLESS STEEL
L	ALUMINIUM

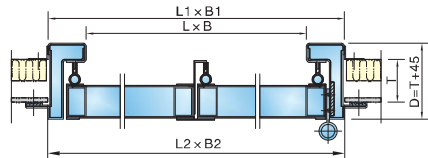
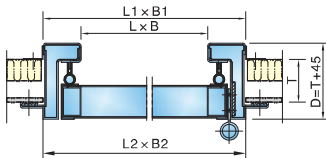
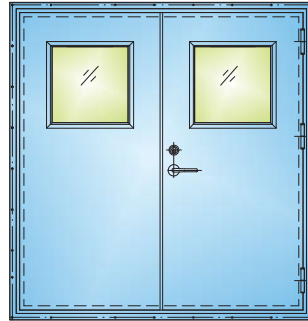

TYPE	SIZE OF DOORWAY LXB	SIZE OF FRAME L1XB1	SIZE OF B.H.OPENING L2XB2	DEPTH OF FRAME D >80	OPENING	[KG] WEIGHT				OPTION
						ALUMINIUM		STAINLESS STEEL		
SINGLE 262WHL044A-00	1600X600	1695X695	1700X700	T+45	RO	32	31	75	74	PORT LIGHT DOOR CLOSER DOOR STOPPER
	1600X800	1695X895	1700X900			36	35	82	35	
	1700X700	1795X795	1800X800			35	34	78	34	
	1800X800	1895X895	1900X900			38	37	85	37	
DOUBLE 262WHL044B-00	1600X1000	1695X1095	1700X1100	T+45	—	53	52	123	125	
	1600X1200	1695X1295	1700X1300		—	61	60	142	144	
	1800X1600	1895X1695	1900X1700		—	81	80	190	192	

1600X600, 100mm

N-1600X600-100RO 262WHL044A-00

1600X1200, 100mm

L-1600X1200-100 262WHL044B-00



262WHL045-00

GRP WEATHERTIGHT DOOR

THE PRODUCT HAS GRP DOOR LEAF AND STEEL OR STAINLESS STEEL DOOR FRAME, AS WELL AS GOOD WEATHERTIGHTNESS ,USED FOR OUTSIDE DOOR OF SUPERSTRUCTURE.

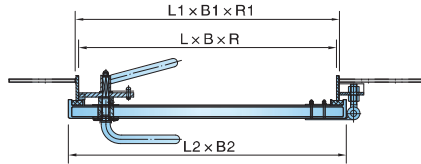
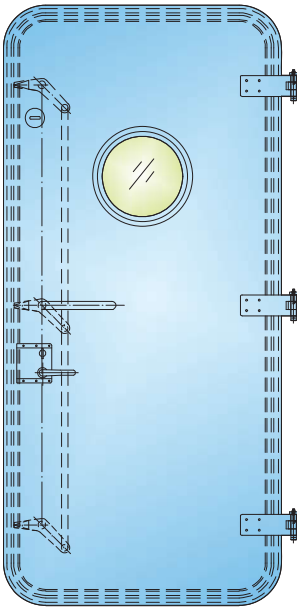

SIZE OF DOORWAY LXB	SIZE OF B.H. OPENING L1XB1	SIZE OF DOOR L2XB2	OPENING	WEIGHT KG	OPTION
1650X600XR100	1670X620XR110	1713X663	右外 RO	88	PORT LIGHT DOOR CLOSER DOOR STOPPER
1700X700XR100	1720X720XR110	1763X763		95	
1750X750XR100	1770X770XR110	1813X813	左外 LO	101	
1800X800XR100	1820X820XR110	1863X863		107	

1700x700

1700x700-RO 262WHL045-00



262WHL008F-00

A60 FIREPROOF SLIDING DOOR

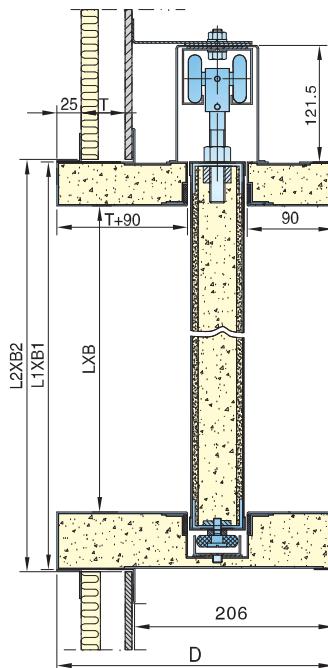
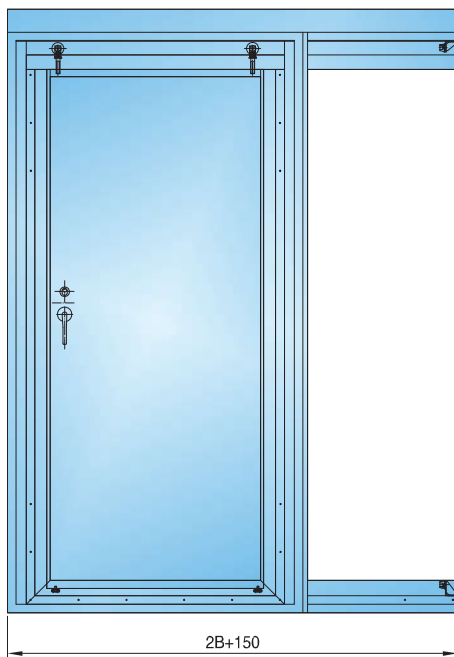

SIZE OF DOORWAY LXB	SIZE OF OUTLINE L1XB1	SIZE OF B.H. OPENING L2XB2	D	OPENING	WEIGHT KG
1700X700	1820X820	1825X825	T+241	右 R 左 L	150
1750X750	1870X870	1875X875			170
1800X800	1920X920	1925X925			187
2075X1875	2195X1995	2200X2000			293

1700X700, D350

A60-1700X700-350R 262WHL008F-00



262WHL008F(120)-00

H120 FIREPROOF SLIDING DOOR

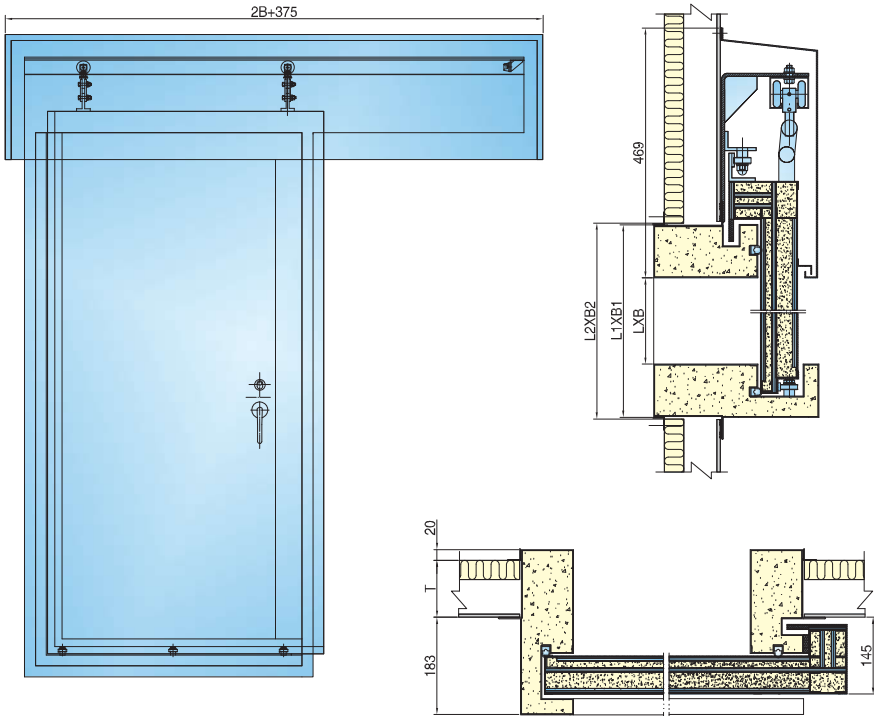

SIZE OF DOORWAY LXB	SIZE OF OUTLINE L1XB1	SIZE OF B.H. OPENING L2XB2	D	OPENING	WEIGHT KG
1700X700	1900X900	1905X905	T+203	R	180
1750X750	1950X950	1955X955			204
1800X800	2000X1000	2005X1005		L	224
1900X900	2100X1100	2105X1105			264

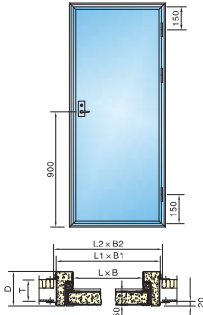
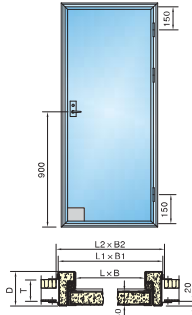
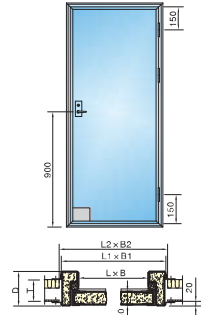
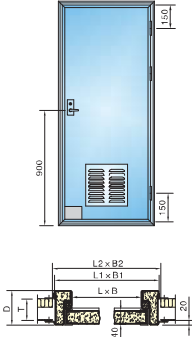
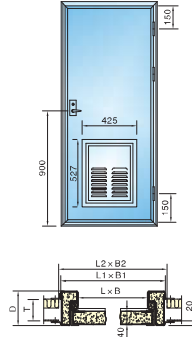
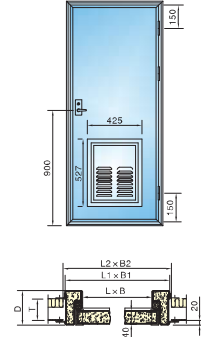

1700X700, D300 H120

H120-1700X700-300R 262WHL008F-(120)-00

CB*3234-84
SINGLE LEAF FIREPROOF DOOR

A60

A15 , A30

A0

B15

B15-S WITH E-E VENT LOUVER

B0-S WITH E-E VENT LOUVER

CLASS	SUBDIVISION	OPENING
A CLASS A	A60	Ll(ZN) LO (ZW) RI (YN) RO (YW)
	A30	
	A15	
	A0	
B CLASS B	B15	
	B15-S	
	B0-S	

SUIT THE BULKHEAD

A	—	
B	—	
C	—	

CB*3234-84

SINGLE LEAF FIREPROOF DOOR

CLASS	SIZE OF DOORWAY LXB	FRAME SIZE L1XB1	SIZE OF B.H. OPENING L2XB2	T	D	KG			
						A0	A15	A30	A60
CLASS A	1650X600	1750X700	1755X705	DECIDED BY DESIGNER	T+45	61.75	88.08	106.53	112.26
	1650X650	1750X750	1755X755			64.51	92.87	111.71	117.83
	1650X700	1750X800	1755X805			67.02	97.4	116.99	123.52
	1650X750	1750X850	1755X855			69.7	102.1	122.17	129.09
	1650X800	1750X900	1755X905			72.29	106.72	127.35	134.68
	1700X600	1800X700	1805X705			63.29	90.41	109.33	115.21
	1700X650	1800X750	1805X755			66.02	95.21	114.71	121.01
	1700X700	1800X800	1805X805			66.77	100.06	120.03	126.74
	1700X750	1800X850	1805X855			71.41	104.77	125.31	132.44
	1750X750	1850X850	1855X855			73.2	107.51	128.44	135.76
	1750X800	1850X900	1855X905			76	112.46	133.87	141.61
	1800X600	1900X700	1905X705			66.53	95.2	114.96	121
	1800X650	1900X750	1905X755			69.29	100.15	120.46	121.14
	1800X700	1900X800	1905X805			72.16	105.23	126.06	133.14
	1800X750	1900X850	1905X855			75	110.27	131.58	139.1
1800X800	1900X900	1905X905	77.87	115.35	137.56	145.5			
1850X600	1950X700	1955X705	68.05	97.48	117.7	124.08			
1850X650	1950X750	1955X755	70.97	102.66	123.38	130.2			
1850X700	1950X800	1955X805	73.89	107.84	129.06	136.32			
1850X750	1950X850	1955X855	76.81	113.03	135.14	142.84			
1850X800	1950X900	1955X905	79.62	118.1	140.5	148.65			

CLASS	SIZE OF DOORWAY LXB	FRAME SIZE L1XB1	SIZE OF B.H. OPENING L2XB2	T	D	KG	
						B0	B15
CLASS B	1850X600	1730X680	1735X685	DECIDED BY DESIGNER	T+45	55.88	95.01
	1850X650	1730X730	1735X735			58.64	100.1
	1850X700	1730X780	1735X785			61.15	104.93
	1850X750	1730X830	1735X835			63.83	109.94
	1850X800	1730X880	1735X885			66.42	114.85
	1700X600	1780X680	1785X685			57.24	97.46
	1700X650	1780X730	1785X735			59.97	102.56
	1700X700	1780X780	1785X785			62.72	107.71
	1700X750	1780X830	1785X835			65.36	112.72
	1700X800	1780X880	1785X885			68.11	117.77
CLASS B	1750X600	1830X680	1835X685	DECIDED BY DESIGNER	T+45	58.67	99.95
	1750X650	1830X730	1835X735			61.47	105.19
	1750X700	1830X780	1835X785			64.18	110.35
	1750X750	1830X830	1835X835			66.98	115.49
	1750X800	1830X880	1835X885			69.78	120.74
	1800X600	1880X680	1885X685			60.13	102.51
	1800X650	1880X730	1885X735			62.89	107.75
	1800X700	1880X780	1885X785			65.76	113.03
	1800X750	1880X830	1885X835			68.6	118.37
	1800X800	1880X880	1885X885			71.47	123.95
CLASS B	1850X600	1930X680	1935X685	DECIDED BY DESIGNER	T+45	61.47	104.9
	1850X650	1930X730	1935X735			64.39	110.28
	1850X700	1930X780	1935X785			67.31	115.76
	1850X750	1930X830	1935X835			70.23	121.45
	1850X800	1930X880	1935X885			73.04	126.62

NOTE: STOPPER, DOOR CLOSERS COULD BE EQUIPPED ACC TO CUSTOMER'S REQUIREMENTS.

1650X650 A15

A15(LO)-B1650X650 CB*3234-84

1800X750 B15

B15-S(RI)-C 1800X750mm CB*3234-84



262WHL016-00 A0
262WHL016B-00 A30
262WHL005A-00 A60
262WHL660-00 A60

CLASS A FIREPROOF DOOR WITH SQUARE WINDOW/HOSE PORT

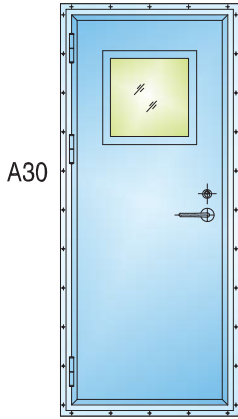

A30

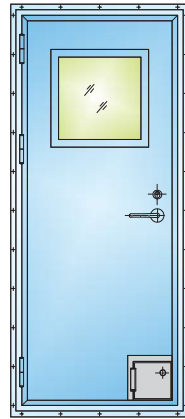

A60

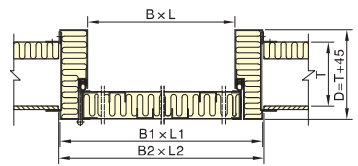
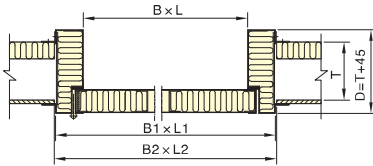

mm

SIZE OF DOORWAY BXL	FRAME SIZE B1XL1	SIZE OF B.H. OPENING B2XL2	WEIGHT KG
600X1650	700X1750	705X1755	92
650X1650	750X1750	755X1755	97
700X1650	800X1750	805X1755	102
600X1700	700X1800	705X1805	95
650X1700	750X1800	755X1805	98
700X1700	800X1800	805X1805	101
700X1750	800X1850	805X1855	104
1400X2300	1500X2400	1505X2405	221

D=100mm A60
THE WEIGHT IS CALCULATED FOR A60 DOOR AT D=100mm.

DWG.NO.	DESCRIPTION	OPTION	
		WINDOW	HOSE PORT
262WHL016-00	A0 FIRE PROOF DOOR	○	●
262WHL016B-00	A30 FIRE PROOF DOOR	●	○
262WHL005A-00	A60 FIRE PROOF DOOR	●	●
262WHL660-00	A60 FIRE PROOF DOOR	●	●

NOTE: STOPPER, DOOR CLOSERS COULD BE EQUIPPED ACC. TO CUSTOMER'S REQUIREMENTS.

650X1650 A60

A60(LO)-B-650X1650 262WHL005A-00



262WHL673-00

B15 FIREPROOF DOOR WITH WINDOW AND EMERGENCY EXIT

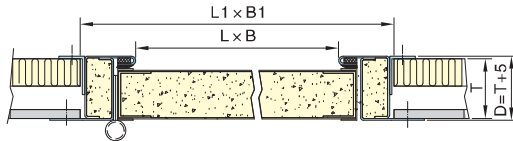
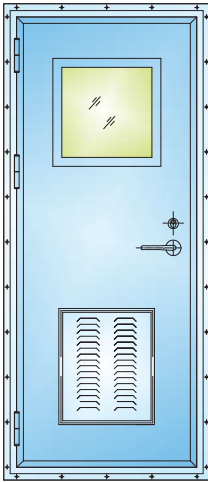

mm

SIZE OF DOORWAY BXL	SIZE OF B.H. OPENING B2XL2	WEIGHT KG	OPTION
600X1650	685X1735	62	PORT LIGHT EMERGENCY EXIT VENT DOOR CLOSER DOOR STOPPER
650X1650	735X1735	65	
700X1650	785X1735	68	
600X1700	685X1785	65	
650X1700	735X1785	68	
700X1700	785X1785	71	
1200X2300	1285X2385	128	

THE WEIGHT IS CALCULATED (AT D=100mm).

650X1650 B15
B15-650X1650 262WHL673-00



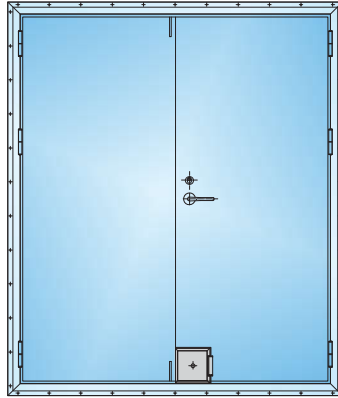

262WHL005S-00

A60 CLASS DOUBLE LEAVES FIREPROOF DOOR (WITH SMALL FIRE FIGHTING DOOR)



SUIT THE BULKHEAD

A	---	
B	---	
C	---	

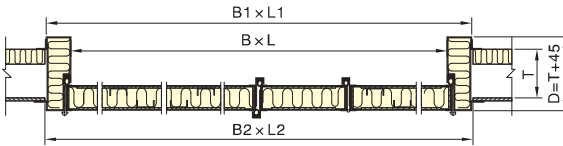

mm

SIZE OF DOORWAY BxL	FRAME SIZE B1xL1	SIZE OF B.H. OPENING B2xL2	WEIGHT KG	OPTION
1200X1700	1294X1794	1300X1800	142	DOOR CLOSER DOOR STOPPER HOSE PORT
1300X1700	1394X1794	1400X1800	148	
1400X1700	1494X1794	1500X1800	154	
1100X1750	1194X1844	1200X1850	150	
1200X1750	1294X1844	1300X1850	157	
1300X1750	1394X1844	1400X1850	164	
1400X1750	1494X1844	1500X1850	171	
1550X1850	1644X1944	1650X1950	196	

THE WEIGHT IS CALCULATED (AT D=100mm).

1200X1700
 A60-B-1200X1700 262WHL005S-00

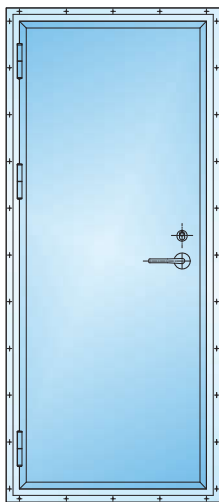
262WHL004B-00ST
H30b ALUMINIUM FIREPROOF DOOR

SUIT THE BULKHEAD

A	—	
B	—	
C	—	

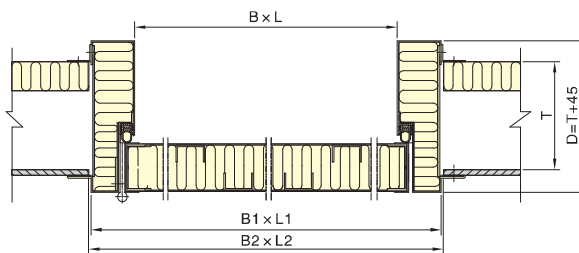

mm

SIZE OF DOORWAY BXL	FRAME SIZE B1XL1	SIZE OF B.H. OPRNING B2XL2	WEIGHT KG	OPTION
600X1650	700X1750	705X1755	46	DOOR CLOSER DOOR STOPPER
650X1650	750X1750	755X1755	48	
700X1650	800X1750	805X1755	50	
600X1700	700X1800	705X1805	47	
650X1700	750X1800	755X1805	49	
700X1700	800X1800	805X1805	51	
700X1750	800X1850	805X1855	53	
800X1850	900X1950	905X1955	59	

THE WEIGHT IS CALCULATED AT D=100mm.

 600X1650 H30b
 H30b(LO)-B-600X1650 262WHL004B-00ST



262WHL004FD-00

A0,A30 FIREPROOF ANTI-THEFT DOOR

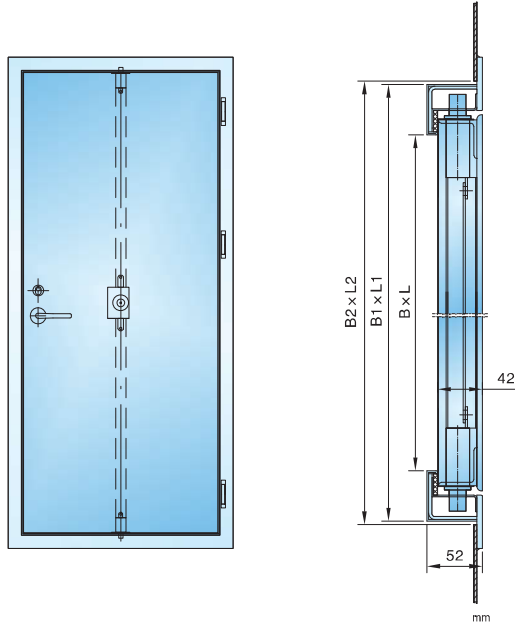

SIZE OF DOORWAY BXL	FRAME SIZE B1XL1	SIZE OF B.H. OPRNING B2XL2	KG WEIGHT	
			A0	A30
600X1650	700X1750	705X1755	74	80
650X1650	750X1750	755X1755	79	84
700X1650	800X1750	805X1755	84	88
600X1700	700X1800	705X1805	77	83
650X1700	750X1800	755X1805	80	86
700X1700	800X1800	805X1805	83	89
700X1750	800X1850	805X1855	87	91

650X1650

A30(RO)-650X1650 262WHL004FD-00



CB*3217-84

STEEL SOUNDPROOF GAS-RETARDING DOOR

USED FOR ENGINE CONTROL ROOM AND SO ON.

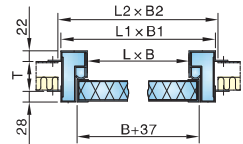
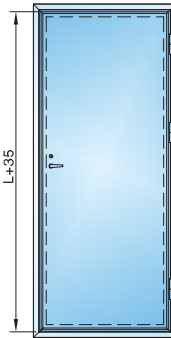
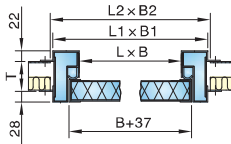
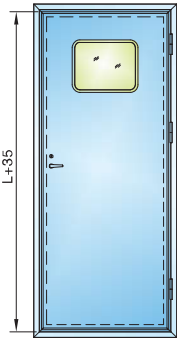

TYPE	SIZE OF DOORWAY LXB	FRAME SIZE L1XB1	SIZE OF R.H. OPENING L2XB2	D ≥80	OPENING	WEIGHT
						KG
A AZ	1650X600	1743X693	1750X700	T+50	LO	68
	1750X700	1843X793	1850X800			73
	1650X800	1743X893	1750X900			73
B BZ	1650X600	1743X693	1750X700		RO	81.5
	1750X700	1843X793	1850X800			86.5
	1650X800	1743X893	1750X900			89.9
C CZ	1650X600	1743X693	1750X700		LI	81.5
	1750X700	1843X793	1850X800			86.5
	1650X800	1743X893	1750X900			85

A	WITHOUT LIGHT	USED FOR SINGLE WALL
AZ	WITH DOUBLE LIGHT	
B	WITHOUT LIGHT	USED FOR DOUBLE WALLS
BZ	WITH DOUBLE LIGHT	
C	WITHOUT LIGHT	USED FOR THREE WALLS
CZ	WITH DOUBLE LIGHT	

1750X700mm D 100
BZ1750X700-100LI CB*3217-84



CB/T3281-1997

ALUMINIUM HOLLOW CABIN DOOR

USED FOR CABIN OF VARIOUS KINDS OF SHIP AND WAR SHIPS,
THE DOOR SURFACE WILL BE ANODIZED BAKING FINISHED OR PVC COVERED.

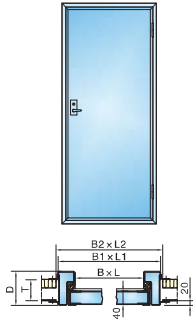

TYPE A HOLLOW DOOR

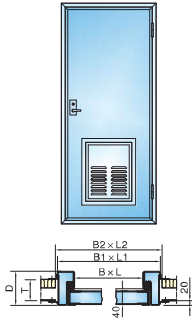

TYPE B HOLLOW DOOR
WITH E-E HOLE

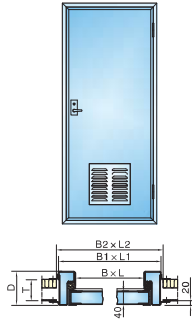

TYPE C HOLLOW DOOR
WITH VENT.

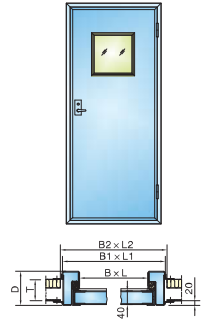

TYPE D HOLLOW DOOR
WITH FIXED LIGHT

CLASS	OPENING	SIZE OF DOORWAY BXL	FRAME SIZE B1XL1	SIZE OF B.H.OPENING B2XL2	D (≥75)	WEIGHT KG
A	LO	600X1600	680X1680	686X1686	T+45	23.6
		650X1650	730X1730	736X1736		24.97
		700X1750	780X1830	786X1836		26.83
		800X1750	880X1830	886X1836		28.62
B	RO	600X1600	680X1680	686X1686		34.51
		650X1650	730X1730	736X1736		35.88
		700X1750	780X1830	786X1836		37.78
		800X1750	880X1830	886X1836		39.71
C	LI	600X1600	680X1680	686X1686		24.61
		650X1650	730X1730	736X1736		26
D	RI	700X1750	780X1830	786X1836		27.87
		800X1750	880X1830	886X1836		29.76
		600X1600	680X1680	686X1686		26.72
		650X1650	730X1730	736X1736		28.41
		700X1750	780X1830	786X1836		29.8
		800X1750	880X1830	886X1836		31.73

FRAME TYPE	CODE
STANDARD	K1
FLANG TYPE	K2

650X1650D150, B
B650X1650X150RO-K1 CB/T 3281-1997



262WHL009G-00

STEEL SOUND PROOF DOOR

SOUND REDUCE VALUE 47 dB(A)

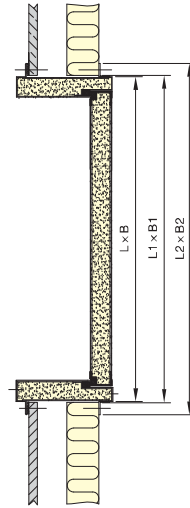
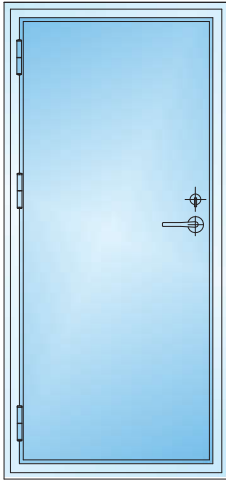

TYPE	
DESCRIPTION	CODE
USED FOR SINGLE WALL AND WITHOUT LIGHT	A
USED FOR SINGLE WALL AND WITH LIGHT	AZ
USED FOR DOUBLE WALLS AND WITHOUT LIGHT	B
USED FOR DOUBLE WALLS AND WITH LIGHT	BZ
USED FOR THREE WALLS AND WITHOUT LIGHT	C
USED FOR THREE WALLS AND WITH LIGHT	CZ

DOORWAY SIZE L x B	FRAME SIZE L1 x B1	OPENING SIZE L2 x B2	WEIGHT KG	OPTION
1400X600	1494X694	1500X700	60	DOOR CLOSER DOOR STOPPER PORT LIGHT
1600X600	1694X694	1700X700	66	
1800X750	1894X844	1900X850	76.5	

1650X800 100
BZ1650X800X100RI 262WHL009G-00



ALUMINIUM SOUND PROOF DOOR

262WHL009A-00
262WHL009T-00

262WHL009A-00

SOUND PROOF VALUE 37 dB

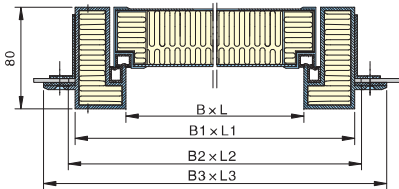
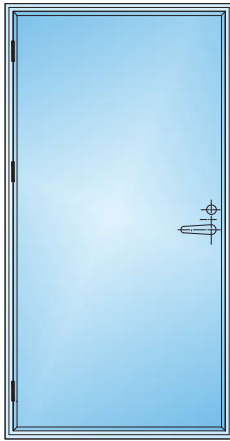

262WHL009T-00

SOUND PROOF VALUE 35 dB

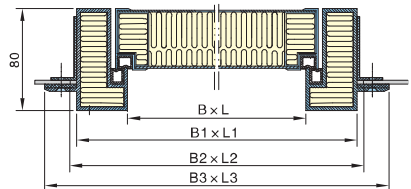
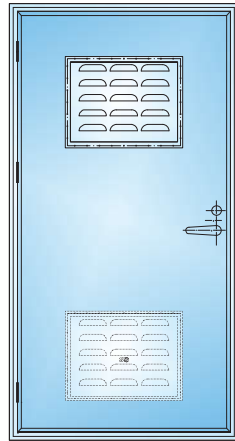

SIZE OF DOORWAY BXL	FRAME SIZE B1XL1	SIZE OF B.H. OPENING B2XL2	SIZE OF OUTLINE B3XL3	WEIGHT KG		OTHER OPTION
				NO VENT 262WHL009A-00	WITH VENT 262WHL009T-00	
600X1650	680X1730	686X1736	730X1780	48.5	50.4	DOOR CLOSER DOOR STOPPER
700X1750	780X1830	786X1836	830X1880	56.5	58.4	

600X1650
600X1650-RI HL009A-00
600X1650
600X1650-LI 262WHL009T-00





262WHL009F-00

A0 SOUND & FIREPROOF DOOR

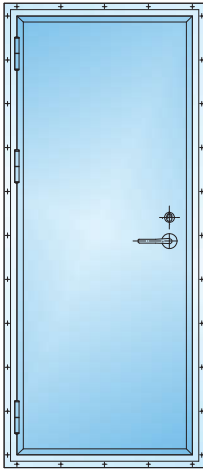
SOUND-REDUCE VALUE 35dB



SUIT FOR BULKHEAD

A	—	
B	—	
C	—	

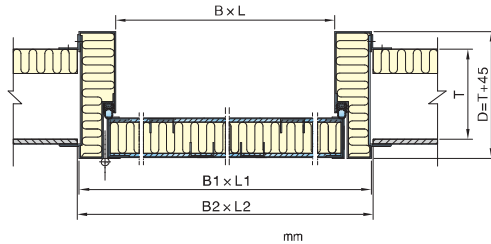

mm

SIZE OF DOORWAY BXL	FRAME SIZE B1XL1	SIZE OF B.H. OPENING B2XL2	WEIGHT KG
600X1650	700X1750	705X1755	107
650X1650	750X1750	755X1755	112
700X1650	800X1750	805X1755	117
600X1700	700X1800	705X1805	110
650X1700	750X1800	755X1805	115
700X1700	800X1800	805X1805	120
700X1750	800X1850	805X1855	123
800X1850	900X1950	905X1955	139

THE WEIGHT IS CALCULATED (AT D=100mm).

650X1700 A0
 A0 (LO)-B-650X1700 262WHL009F-00



262WHL006H-00

H120 FIREPROOF DOOR

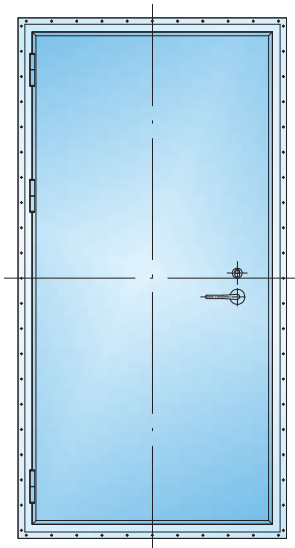

SUIT FOR BULKHEAD

A	—	
B	—	
C	—	

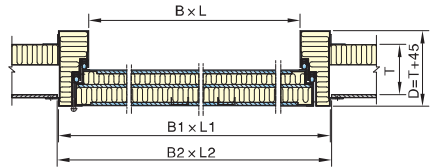

mm



SIZE OF DOORWAY BXL	FRAME SIZE B1XL1	SIZE OF B.H. OPRNING B2XL2	WEIGHT KG
600X1650	720X1770	725X1775	135
650X1650	770X1770	775X1775	141
700X1650	820X1770	825X1775	148
600X1700	720X1820	725X1825	138
650X1700	770X1820	775X1825	145
700X1700	820X1820	825X1825	152
700X1750	820X1870	825X1875	156
900X1900	1020X2020	1025X2025	191

THE WEIGHT IS CALCULATED AT D=100mm .

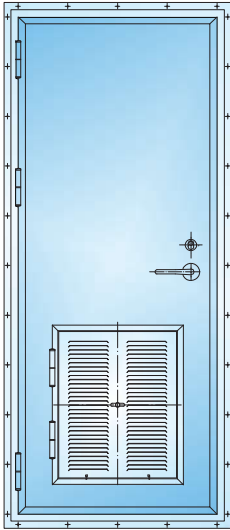
650X1700 H120
 H120 (LO)-B-650X1700 260WHL006H-00

262WHL005T-00
A60 CLASS FIREPROOF DOOR WITH ESCAPE & VENTILATION FENCE

SUIT FOR BULKHEAD

A	—	
B	—	
C	—	

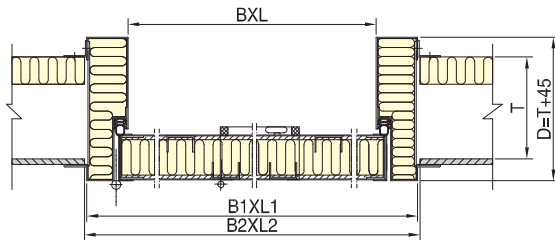

mm

SIZE OF DOORWAY BXL	FRAME SIZE B1XL1	SIZE OF B.H. OPENING B2XL2	WEIGHT KG
600X1650	700X1750	705X1755	115
650X1650	750X1750	755X1755	120
700X1650	800X1750	805X1755	125
600X1700	700X1800	705X1805	117
650X1700	750X1800	755X1805	123
700X1700	800X1800	805X1805	128
700X1750	800X1850	805X1855	132
900X1850	1000X1950	1005X1955	158

THE WEIGHT IS CALCULATED AT D=100mm .

 650X1650 A60
 A60(LO)-B-650X1650 262WHL005T-00



HYDRAULIC SLIDING WATERTIGHT DOOR

262WHL094-00
 CB/T3007-2000)

IT IS WATERTIGHT DOOR FOR BULKHEAD BELOW WATERLINE, WHICH IS USUALLY USED BETWEEN ENGINE ROOM AND SHAFT TUNNEL, OR BETWEEN ENGINE ROOM AND BOILER ROOM, OR BETWEEN ENGINE ROOM AND STEERING GEAR ROOM, ETC. IT COMPLIES WITH CLASS RULES FOR SEA GOING SHIP AND SOLAS.

THIS DOOR CAN BE POWER AND MANUALLY OPERATED FROM BOTH SIDES OF DOOR, AS WELL AS, HAND OPERATION COULD BE PROVIDED ON UPPER DECK IF NEED.

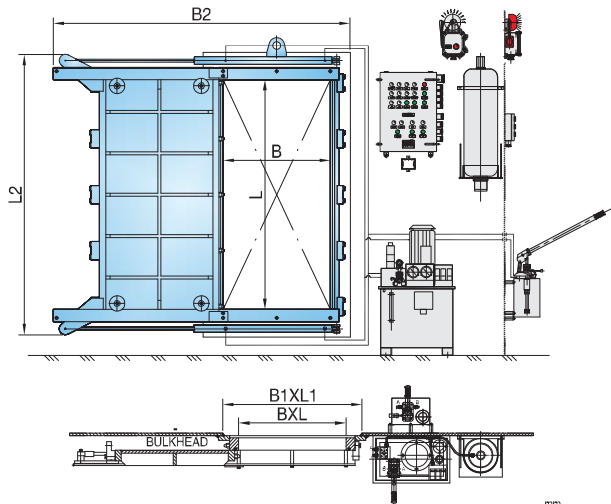

SIZE OF DOORWAY BXL	SIZE OF B.H. OPENING B1XL1	SIZE OF OUTLINE B2XL2	OPENING DIRECTION	WEIGHT KG
600X1200	800X1400	1720X1480	L R	765
700X1400	900X1600	1920X1680		872
800X1800	1000X2000	2120X2080		1020
900X1900	1100X2100	2320X2180		1100
1000X2000	1200X2200	2520X2280		1230
1200X2000	1400X2200	2920X2280		1350

700X1400mm
 700X1400-L 262WHL094-00



262WHL073-00

A60 HYDRAULIC SLIDING WATERTIGHT DOOR

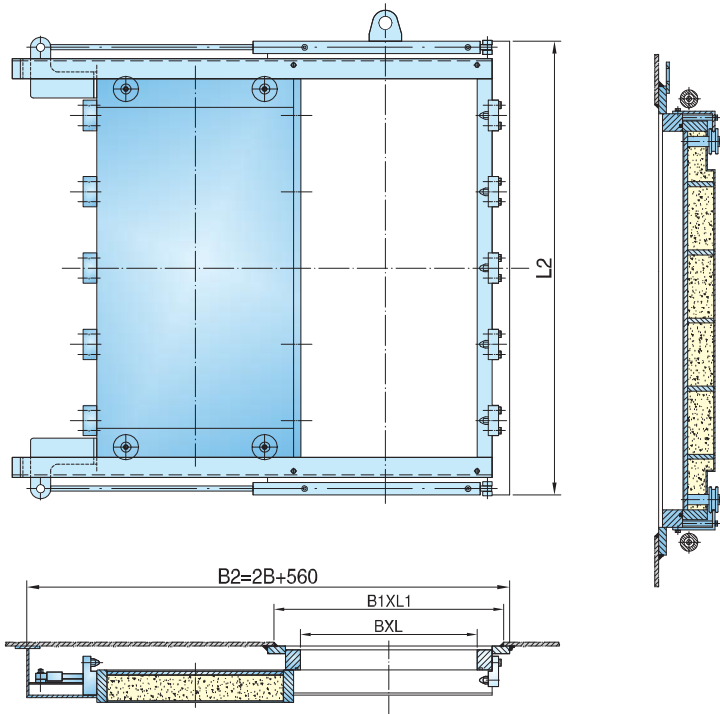

mm

SIZE OF DOORWAY BXL	SIZE OF B.H. OPENING B1xL1	SIZE OF OUTLINE B2XL2	OPENING DIRECTION	WEIGHT KG
600X1200	800X1400	1760X1500	L R	870
700X1400	900X1600	1960X1700		990
800X1800	1000X2000	2160X2100		1100
900X1900	1100X2100	2360X2200		1210
1000X2000	1200X2200	2560X2300		1350
1200X2000	1400X2200	2960X2300		1510

700X1400 A60
 A60-700X1400-L 262WHL073-00



262WHL100-00

HYDRAULIC HINGED WATERTIGHT DOOR

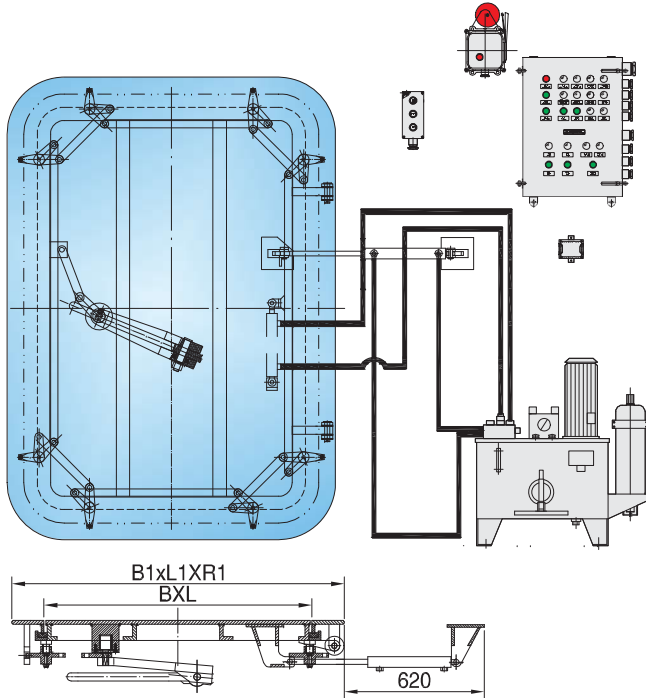

mm

SIZE OF DOORWAY BXL	SIZE OF B. H. OPENING B1XL1XR1	SIZE OF OUTLINE B2XL2XR2	OPENING DIRECTION	WEIGHT KG
600X1000	840X1240XR220	840X1240XR220	L R	375
600X1100	840X1340XR220	840X1340XR220		391
600X1200	840X1440XR220	840X1440XR220		410
700X1200	940X1440XR220	940X1440XR220		429
800X1200	1040X1440XR220	1040X1440XR220		450
900X1200	1140X1440XR220	1140X1440XR220		476

700X1200

700X1200-L 262WHL100-00



262WHL071-00

A0 LANDING DOOR FOR ELEVATOR (TWO PANELS SIDE)

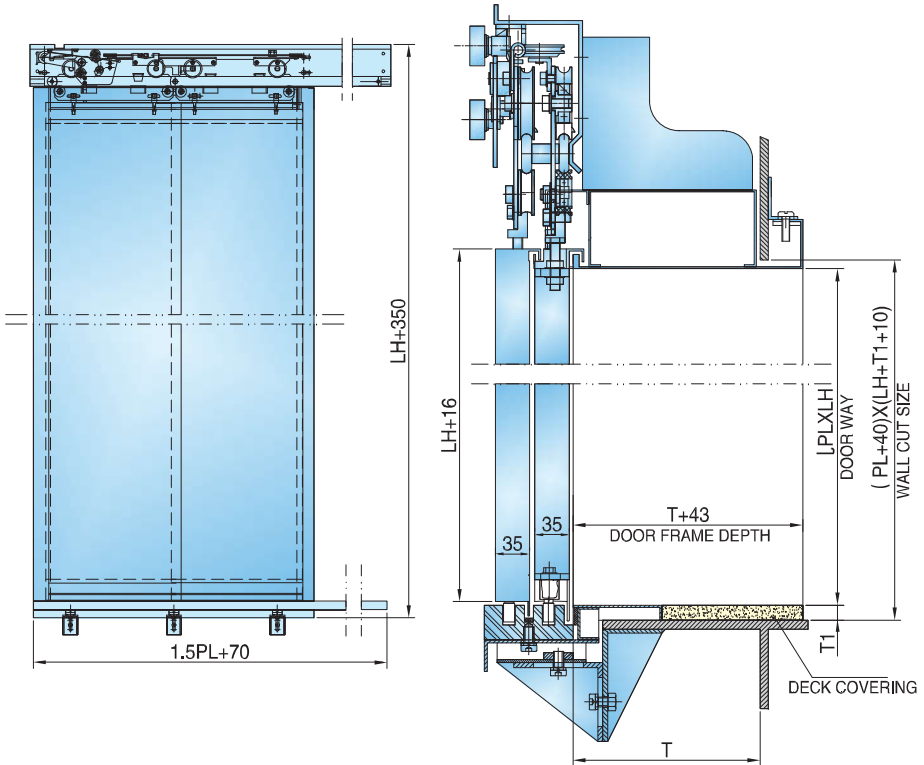

1800X2300 mm.

THE MAXIMUM SIZE IS 1800X2300mm.

PLXLH=1000X2000, 190 A0

A0-1000X2000-190L 262WHL071-00



262WHL072-00

A0 LANDING DOOR FOR ELEVATOR(CENTRE)

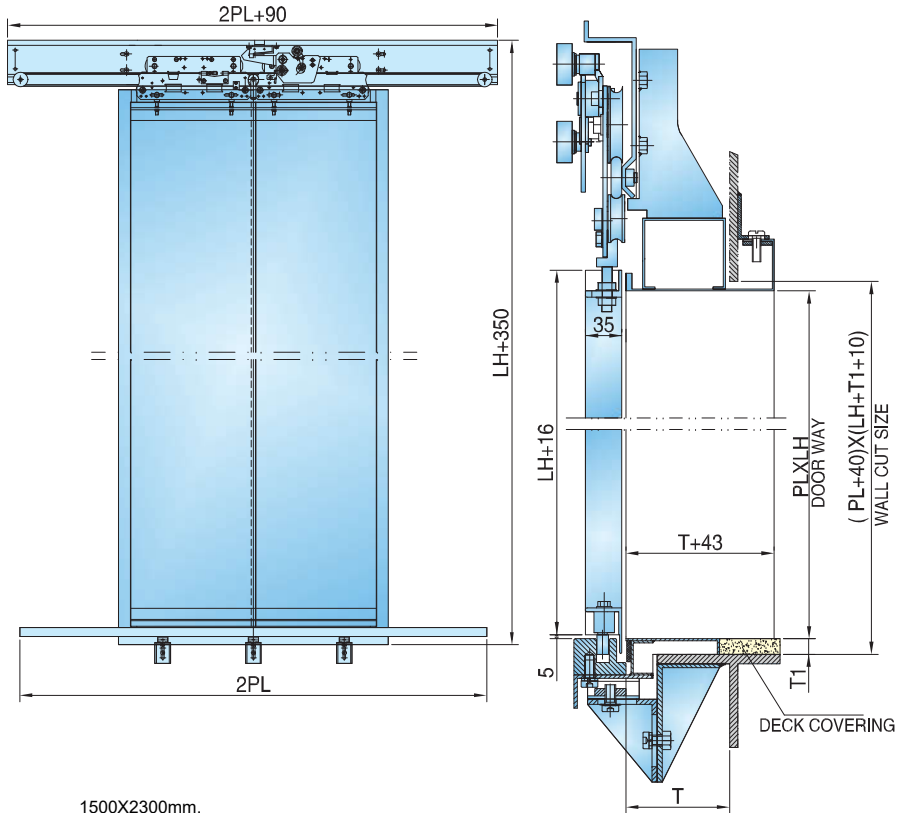

1500X2300mm.
THE MAXIMUM SIZE IS 1500X2300mm.

PLXLH=1000X2000, 100 A0
A0-1000X2000-100 262WHL072-00



GB/T 14413-1993

SIDE SCUTTLES FOR SHIPS

USED FOR SEA-GOING SHIP AND WARSHIP, ALSO COULD BE USED FOR INLAND SHIP.

NAME	TYPE	SIZE OF CLEAR D mm	OPENING TYPE		INSTALL TYPE	MATERIAL CODE		DEADLIGHT RETAINING METHOD	GLASS	APPLICATION SCOPE	
			OPENING	FIXED		BOLTED	WELDED				
HEAVY	A	200 250 300 350 400	(L)	FIXED (N)	BOLTED (B)	112	212 222	HOOK TYPE (G)	TRANSPARENT (Y1)		
			(R)								
MEDIUM	B	200 250 300 350 400 450	(S)	WELDED (W)		112 222 333	212 222 333				PAW TYPE (J)
			(S)								
LIGHT	C	200 250 300 350 400 450	(L)			220 330 110	210 220 230	FEROSTED (Y2)			
			(R)								

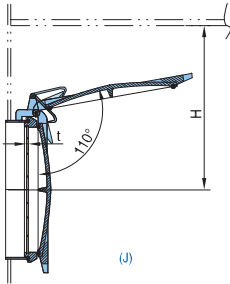
MATERIAL CODE



TYPE	INSTALL TYPE	MATERIAL			MATERIAL CODE
		MAIN FRAME	GLASS HOLDER AND RETAINER	DEADLIGHT	
A	BOLTED	BRASS (1)	BRASS (1)	STEEL (2)	112
	WELDED	STEEL (2)	STEEL (2)	STEEL (2)	212 222
B	BOLTED	BRASS (1)	BRASS (1)	STEEL (2)	112
		STEEL (2)	STEEL (2)	STEEL (2)	212 222
	WELDED	ALUMINIUM (3)	ALUMINIUM (3)	ALUMINIUM (3)	333
		STEEL (2)	BRASS (1)	STEEL (2)	212 222
C	BOLTED	STEEL (2)	STEEL (2)	—	220
		ALUMINIUM (3)	ALUMINIUM (3)	—	330
		BRASS (1)	BRASS (1)	—	110
	WELDED	STEEL (2)	BRASS (1)	—	210
		STEEL (2)	STEEL (2)	—	220
		STEEL (2)	ALUMINIUM (3)	—	230

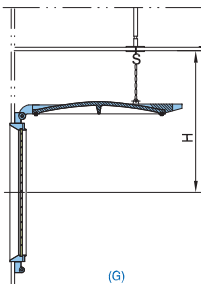

CLEAR LIGHT SIZE D		200	250	300	350	400	450
MIN. DISTANCE FROM CENTER OF SIDE SCUTTLE TO CEILING H	PAW (J)	350	400	450	500	540	580
	HOOK (G)	BY DESIGNER					